

Relay	Lane	Jari Gusev		
10m Ilma-ase launtai	PAS	R10 Y		
2.- 3.2.2019	10. Markun ilma-asekilpailu	Mikkeli Shooting Club		
Series 1	1: 10.0 ↗ 2: 8.0 ← 3: 6.4 ← 4: 4.0 → 5: 8.6 ↗ 6: 2.1 ↗ 7: 7.8 ↗ 8: 5.4 ← 9: 7.6 ↖ 10: 8.8 ↗	Series 2	1: 8.4 ← 2: 10.8x → 3: 5.8 ↗ 4: 5.4 ↓ 5: 9.7 ← 6: 9.0 ↗ 7: 7.7 ↗ 8: 7.1 ← 9: 5.4 ↗ 10: 5.2 ↖	
	Series 68.7		Series 74.5	
	68.7		143.2	
Series 3	1: 4.9 → 2: 6.4 ↗ 3: 3.4 ↖ 4: 7.3 ↗ 5: 9.6 ↗ 6: 9.7 → 7: 8.6 ↘ 8: 8.4 ← 9: 7.5 ← 10: 7.3 ↗	Series 4	1: 5.7 ↖ 2: 9.0 ↓ 3: 6.0 ← 4: 8.4 ← 5: 6.4 ← 6: 6.9 ← 7: 1.9 ← 8: 4.1 → 9: 5.5 → 10: 6.5 ↗	
	Series 73.1		Series 60.4	
	216.3		276.7	
Series 5	1: 9.6 ↗ 2: 7.6 ← 3: 0.0 → 4: 3.5 ← 5: 9.8 → 6: 7.7 ← 7: 10.3x ↗ 8: 8.8 ← 9: 5.9 ↘ 10: 8.2 ↗	Series 6	1: 6.6 ↖ 2: 3.6 → 3: 4.7 ↗ 4: 9.4 ↗ 5: 6.2 ↗ 6: 6.4 ↖ 7: 10.0 ↘ 8: 8.8 ↘ 9: 7.5 ← 10: 7.5 ←	
	Series 71.4		Series 70.7	
	348.1		418.8	

Relay	Lane	Timo Nyström	
10m Ilma-ase lauantai	MA	R10 Y	
2.- 3.2.2019	10. Markun ilma-asekilpailu	Mikkeli Shooting Club	
Series 1	1: 6.2 ← 2: 5.5 ↘ 3: 10.0 ↓ 4: 9.0 ↗ 5: 6.9 ← 6: 6.1 → 7: 10.6x → 8: 8.3 ← 9: 6.4 ← 10: 5.3 ← Series 74.3 74.3	Series 2	1: 6.3 ↘ 2: 8.7 ↗ 3: 5.6 ← 4: 3.3 ← 5: 6.7 ← 6: 7.0 ← 7: 6.4 ↗ 8: 6.7 ↖ 9: 6.2 ← 10: 8.1 ↗ Series 65.0 139.3
Series 3	1: 5.9 → 2: 8.8 → 3: 7.2 → 4: 9.4 ↑ 5: 2.7 → 6: 8.8 ← 7: 5.4 → 8: 8.2 → 9: 4.8 ↑ 10: 7.9 ↑ Series 69.1 208.4	Series 4	1: 8.4 ↘ 2: 0.0 → 3: 8.4 ← 4: 9.6 ↑ 5: 7.1 → 6: 5.7 → 7: 8.5 ↗ 8: 7.3 ↗ 9: 6.3 ↗ 10: 8.2 ← Series 69.5 277.9
Series 5	1: 9.5 ↑ 2: 8.0 ← 3: 10.2x ↓ 4: 1.3 → 5: 9.5 ↓ 6: 9.6 ↗ 7: 6.3 → 8: 7.4 ↘ 9: 7.5 ← 10: 8.1 ↓ Series 77.4 355.3	Series 6	1: 5.9 ← 2: 6.8 ↘ 3: 8.1 → 4: 7.1 ← 5: 5.8 → 6: 6.4 → 7: 8.2 ↖ 8: 4.0 → 9: 5.0 ← 10: 7.9 ↗ Series 65.2 420.5

Relay	Lane	Mikael Toivainen		
10m Ilma-ase lauantai	VS-VA	R10 Y		
2.- 3.2.2019	10. Markun ilma-asekilpailu	Mikkeli Shooting Club		
Series 1	1: 6.4 ↗ 2: 5.5 ↖ 3: 0.0 ↓ 4: 0.0 ↖ 5: 2.1 ↖ 6: 8.2 ↗ 7: 3.8 ↖ 8: 6.2 ↓ 9: 1.4 ← 10: 1.9 ← Series 35.5 35.5	Series 2	1: 0.0 ← 2: 0.0 ↖ 3: 0.0 ← 4: 4.5 ← 5: 6.0 ← 6: 6.7 ↗ 7: 6.5 ← 8: 8.6 ↖ 9: 0.0 ← 10: 6.7 ↗ Series 39.0 74.5	
Series 3	1: 8.2 ← 2: 6.1 ↖ 3: 6.6 ← 4: 7.0 ↖ 5: 0.0 → 6: 6.6 ↖ 7: 5.3 ↑ 8: 7.5 → 9: 0.0 ← 10: 5.3 ↑ Series 52.6 127.1	Series 4	1: 3.1 ↑ 2: 3.4 ↖ 3: 6.4 ↗ 4: 3.6 ↗ 5: 7.1 ↗ 6: 8.3 ↗ 7: 6.9 ↖ 8: 8.9 → 9: 1.8 ← 10: 6.4 → Series 55.9 183.0	
Series 5	1: 0.0 ← 2: 3.9 ↗ 3: 8.1 ← 4: 5.8 → 5: 2.0 ↑ 6: 1.0 ↖ 7: 9.5 ↑ 8: 5.8 ↗ 9: 1.9 ↗ 10: 8.3 ↗ Series 46.3 229.3	Series 6	1: 6.6 ↑ 2: 2.9 ← 3: 9.5 ↗ 4: 1.8 ↖ 5: 4.5 ↖ 6: 8.4 ↖ 7: 5.8 ↖ 8: 1.6 ← 9: 4.8 ↗ 10: 6.8 ↖ Series 52.7 282.0	

Relay	Lane	Tapani Meriläinen	
1	4	10m Ilma-ase lauantai	JA
2.- 3.2.2019		10. Markun ilma-asekilpailu	Mikkeli Shooting Club
Series 1		1: 10.7x → 2: 10.3x ↗ 3: 10.0 ↖ 4: 10.7x ↗ 5: 10.1 ↗ 6: 9.9 ↑ 7: 10.8x ↗ 8: 10.1 ↘ 9: 10.0 ↘ 10: 10.2x ←	Series 2
		Series 102.8	Series 2
		102.8	Series 103.4
			206.2
Series 3		1: 9.9 ↙ 2: 10.3x ↑ 3: 10.1 → 4: 10.1 ↑ 5: 10.1 ↘ 6: 10.6x ↑ 7: 10.4x ↘ 8: 10.1 → 9: 10.8x ↗ 10: 9.9 ↗	Series 4
		Series 102.3	Series 4
		308.5	Series 104.1
			412.6
Series 5		1: 10.1 ↘ 2: 10.0 ↑ 3: 10.3x ↓ 4: 10.3x ↓ 5: 10.5x → 6: 10.2x ↘ 7: 10.0 ↑ 8: 10.0 → 9: 10.4x ← 10: 10.2x ↑	Series 6
		Series 102.0	Series 6
		514.6	Series 103.7
			618.3

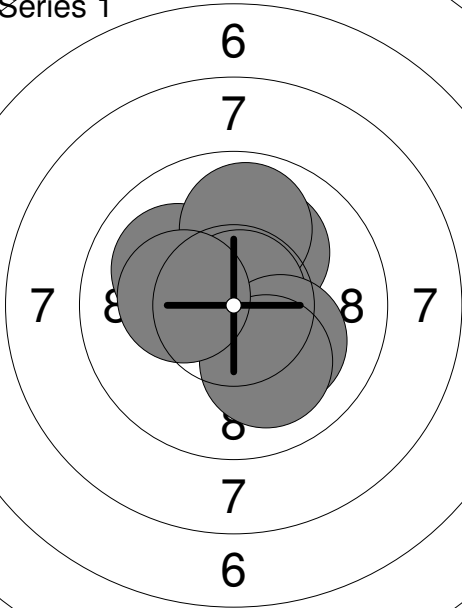
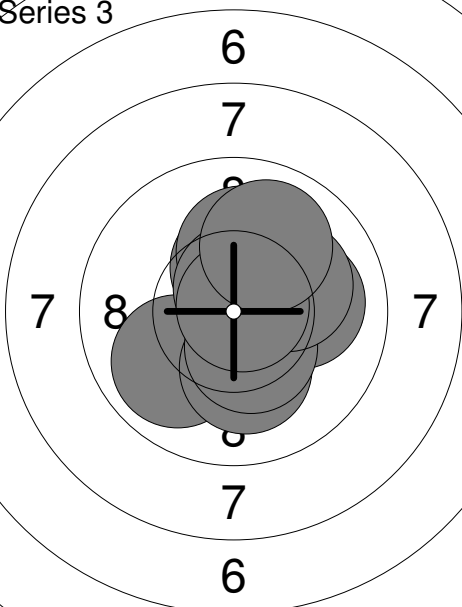
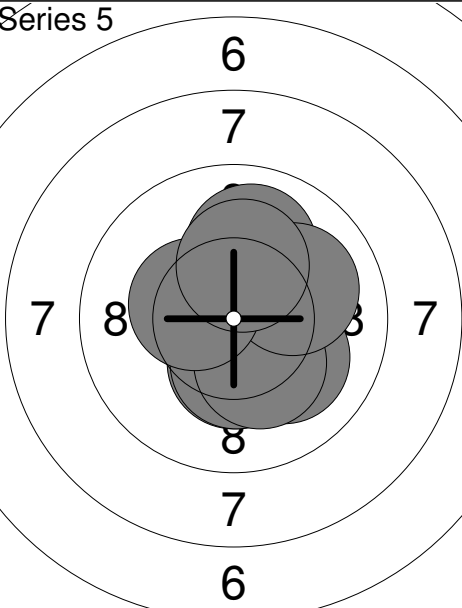
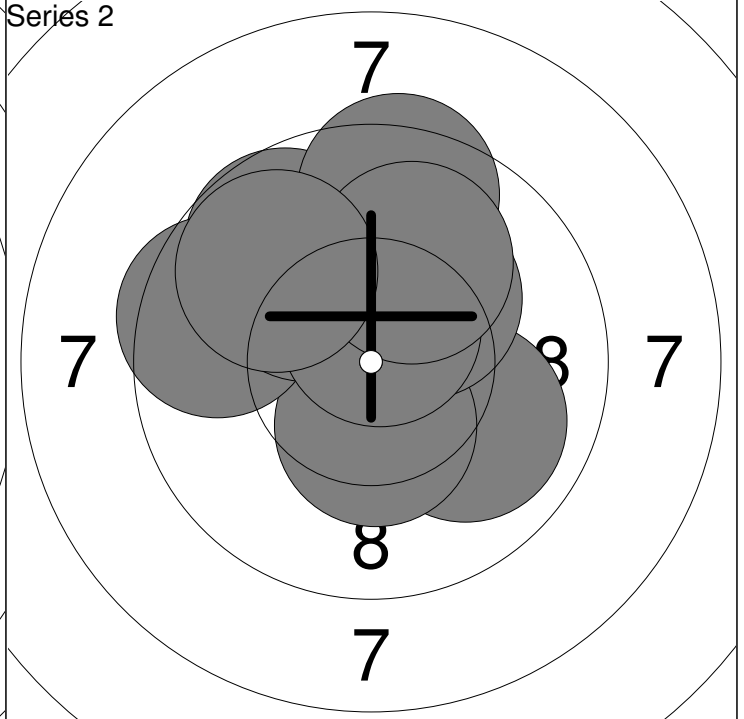
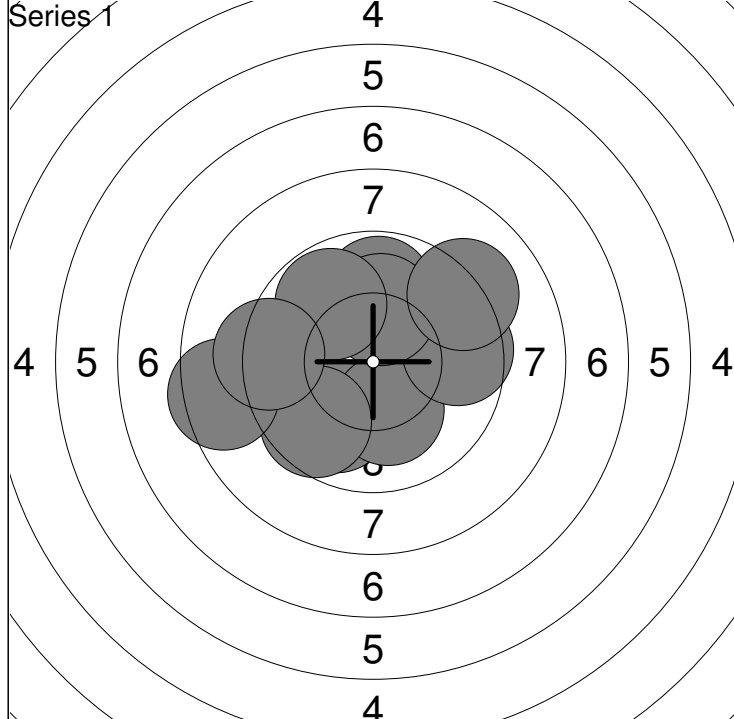

1: 9.9 ↙	6: 10.1 ↑	Series 95.7
2: 10.1 ↓	7: 9.8 ↗	
3: 9.6 →	8: 8.5 ←	Series 95.7
4: 9.6 ↙	9: 9.2 ←	
5: 9.8 ↑	10: 9.1 ↗	

1: 9.9 ↘	6: 10.0 ↖	Series 99.5
2: 9.7 ↗	7: 10.6x ↑	
3: 10.4x ↓	8: 9.4 ↑	Series 195.2
4: 9.5 ←	9: 10.0 ↑	
5: 10.2x ↗	10: 9.8 ↖	

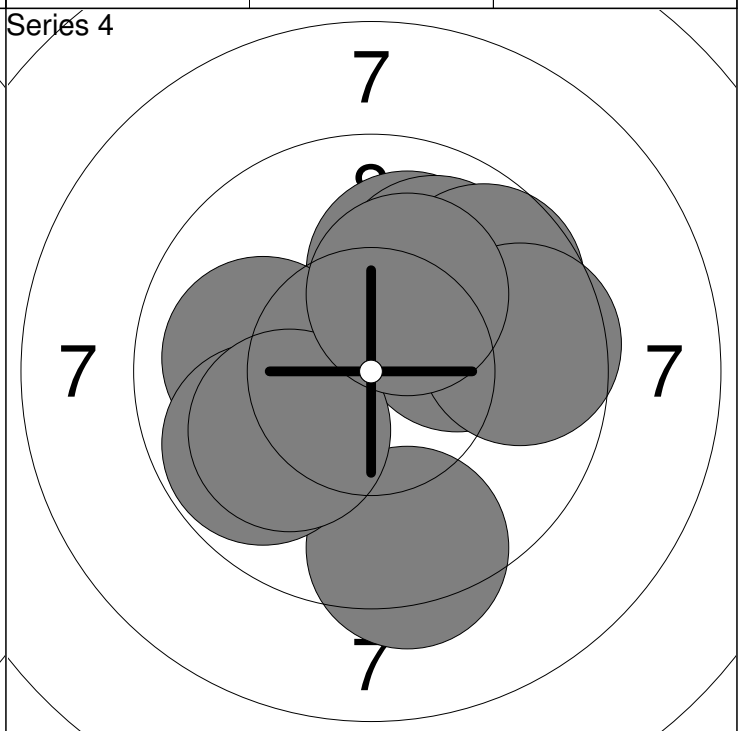
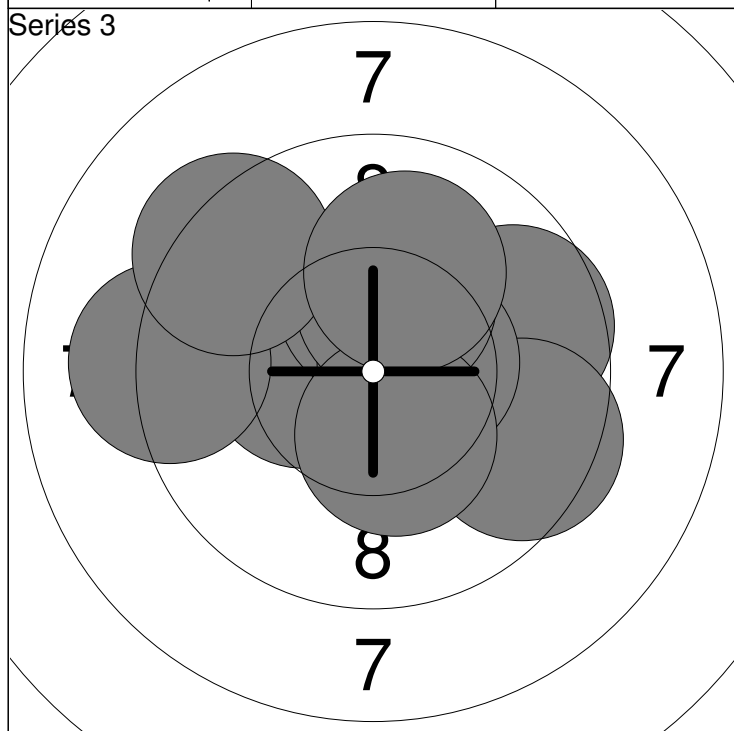

1: 9.6 →	6: 10.5x →	Series 99.2
2: 10.3x ←	7: 10.3x ↑	
3: 10.3x ↑	8: 10.3x ↓	Series 294.4
4: 9.1 ←	9: 9.3 ↗	
5: 9.5 →	10: 10.0 ↑	

1: 10.0 ↑	6: 9.7 ↗	Series 98.6
2: 9.3 ↓	7: 9.8 ←	
3: 9.9 ↗	8: 9.6 →	Series 393.0
4: 10.0 ←	9: 10.0 ↖	
5: 10.1 →	10: 10.2x ↑	

Relay 1	Lane 6	Sonja Myllys
-------------------	------------------	---------------------

10m Ilma-ase lauantai	Hahlo	N16
-----------------------	-------	-----

2.- 3.2.2019	10. Markun ilma-asekilpailu	Mikkeli Shooting Club
--------------	-----------------------------	-----------------------

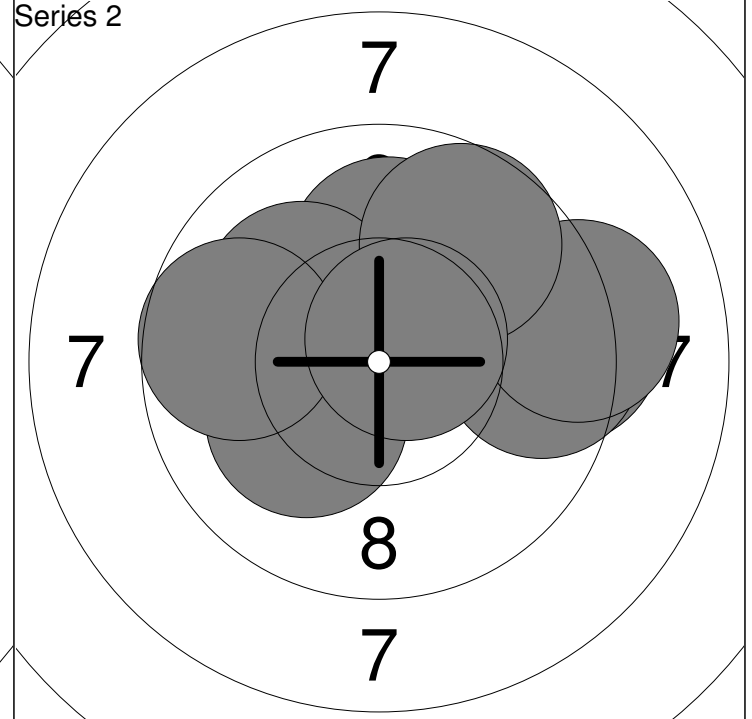
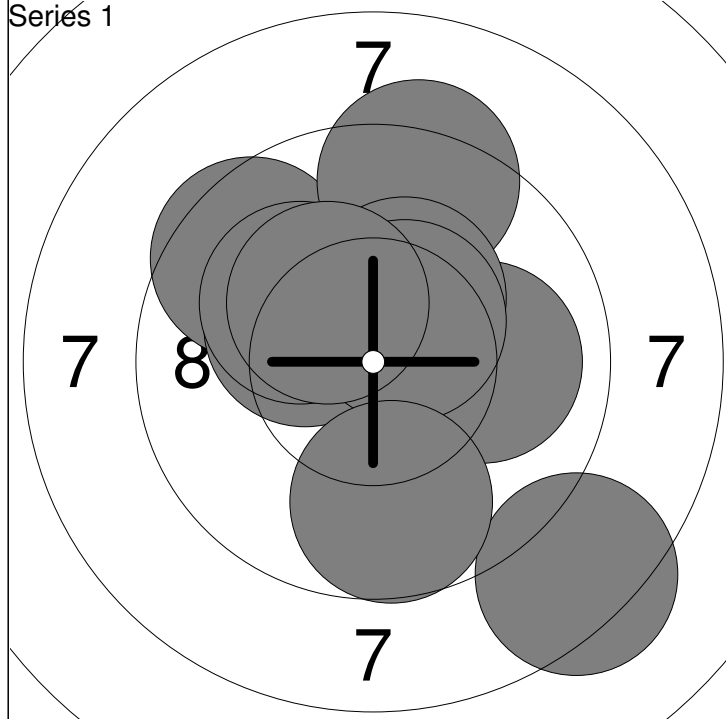

1: 9.5 ↗	6: 10.3x ↗	Series	98.2
2: 8.3 ↘	7: 10.5x ↗		
3: 9.3 ↑	8: 10.1 ↖	98.2	
4: 10.0 →	9: 10.3x ↖		
5: 10.2x ↖	10: 9.7 ↓		

1: 10.0 ↑	6: 9.1 →	Series	98.7
2: 9.3 →	7: 10.1 ↘		
3: 9.5 →	8: 9.7 ↗	196.9	
4: 10.6x ↗	9: 9.7 ←		
5: 10.1 ↖	10: 10.6x ↗		

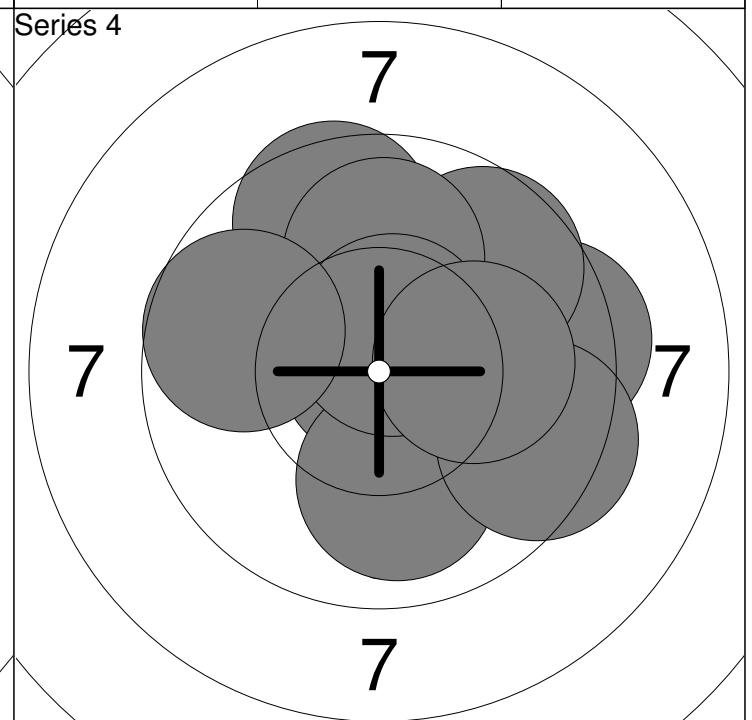
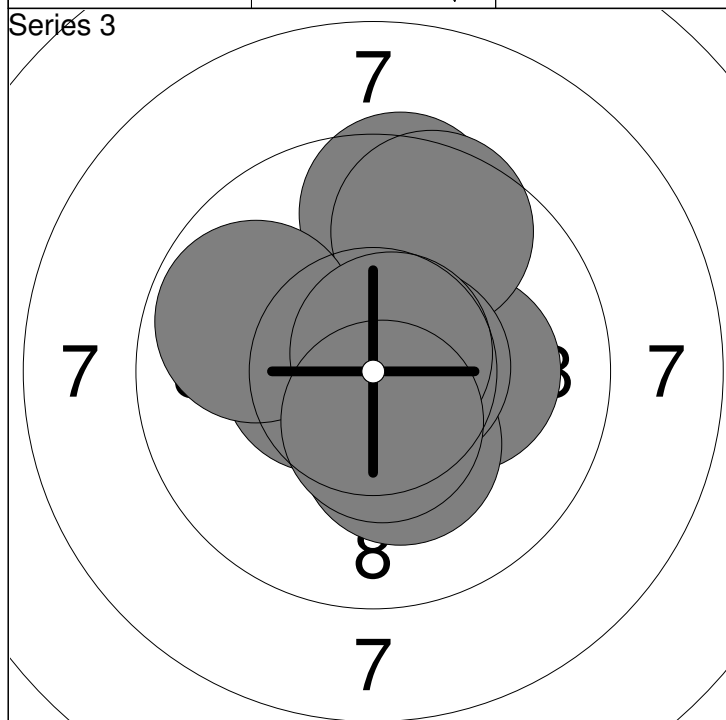

1: 10.7x ↑	6: 9.6 ↗	Series	102.4
2: 9.5 ↑	7: 10.6x →		
3: 10.5x ←	8: 9.8 ↖	299.3	
4: 10.2x →	9: 10.7x ↗		
5: 10.3x ↘	10: 10.5x ↓		

1: 10.8x ↑	6: 9.6 ↗	Series	99.0
2: 9.4 →	7: 9.9 ↑		
3: 9.6 ↗	8: 10.6x ↗	398.3	
4: 9.9 ↓	9: 10.1 →		
5: 9.4 →	10: 9.7 ←		

Mikkelin Ampujat ry

Relay 1	Lane 7	<h1>Aino Nenonen</h1>
-------------------	------------------	-----------------------

10m Ilma-ase lauantai	Hahlo	N16
-----------------------	-------	-----

2.- 3.2.2019	10. Markun ilma-asekilpailu	Mikkeli Shooting Club
--------------	-----------------------------	-----------------------

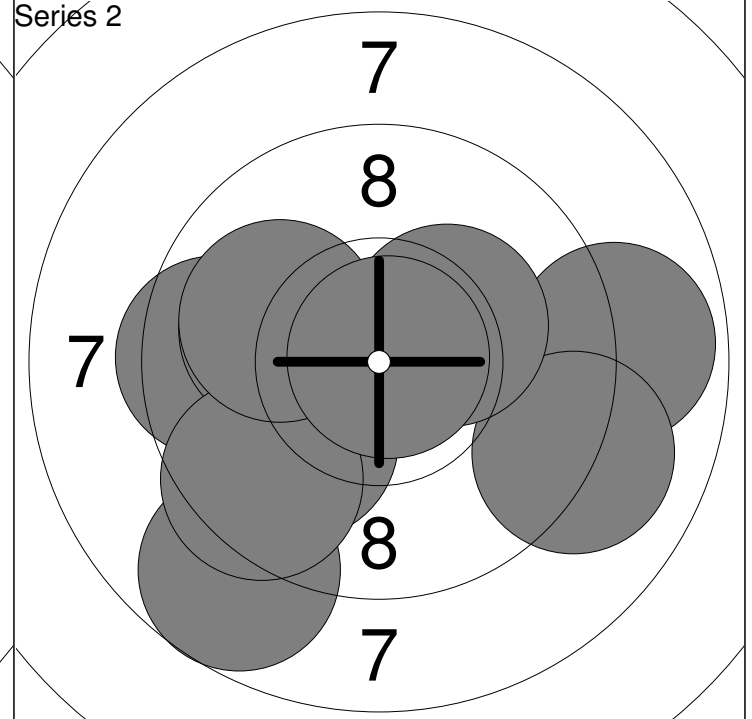
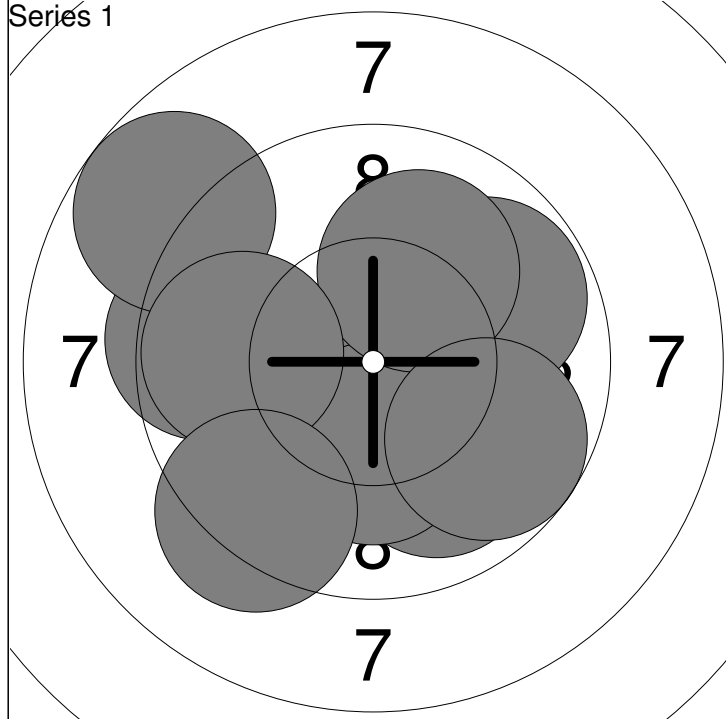

1: 9.9 ↘	6: 9.8 ↗	Series 97.3
2: 9.4 ←	7: 10.1 ↗	
3: 8.7 ↗	8: 9.7 ↘	97.3
4: 10.5x →	9: 9.8 ←	
5: 10.2x ↓	10: 9.2 ↘	

1: 9.9 ↙	6: 8.9 →	Series 96.5
2: 9.5 ←	7: 9.0 ↘	
3: 8.7 ↘	8: 10.0 ←	193.8
4: 10.0 ←	9: 10.3x ↗	
5: 9.4 ↙	10: 10.8x ↗	

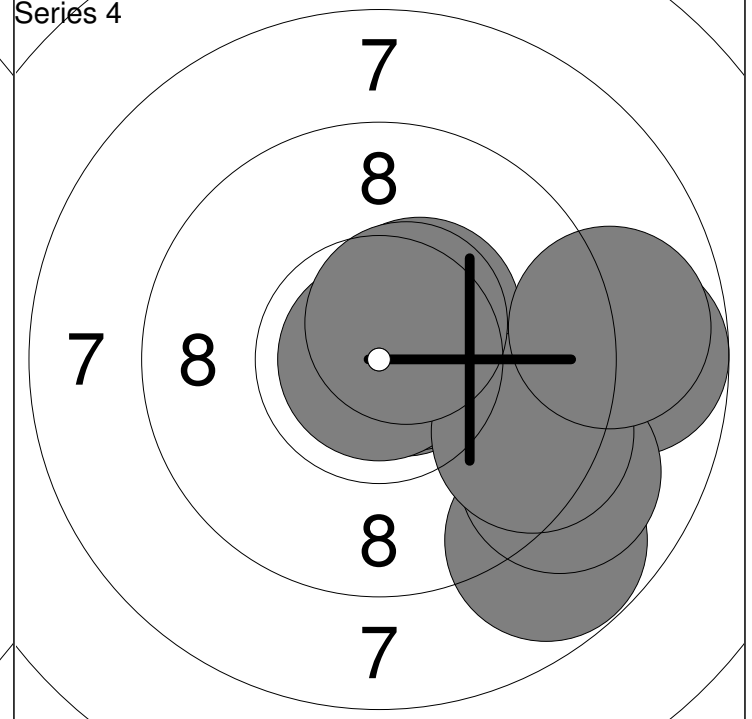
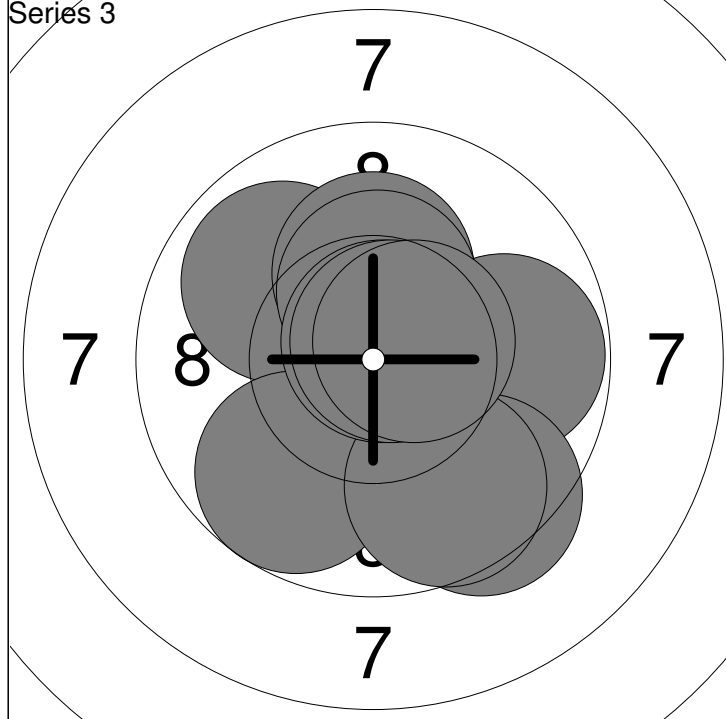

1: 9.8 →	6: 9.7 ↘	Series 100.9
2: 9.9 ↗	7: 9.6 ↘	
3: 10.2x ↑	8: 10.8x ↗	294.7
4: 10.3x ↑	9: 10.7x ↗	
5: 9.4 ↘	10: 10.5x ↗	

1: 8.7 ↘	6: 10.9x	Series 97.9
2: 10.7x →	7: 10.4x ↗	
3: 10.7x →	8: 9.4 ↘	392.6
4: 8.7 →	9: 8.9 →	
5: 9.0 ↘	10: 10.5x ↗	

Mikkelin Ampujat ry

Relay 1	Lane 8	Eetu Rissanen
-------------------	------------------	----------------------

10m Ilma-ase lauantai	HAS	M16
-----------------------	-----	-----

2.- 3.2.2019	10. Markun ilma-asekilpailu	Mikkeli Shooting Club
--------------	-----------------------------	-----------------------

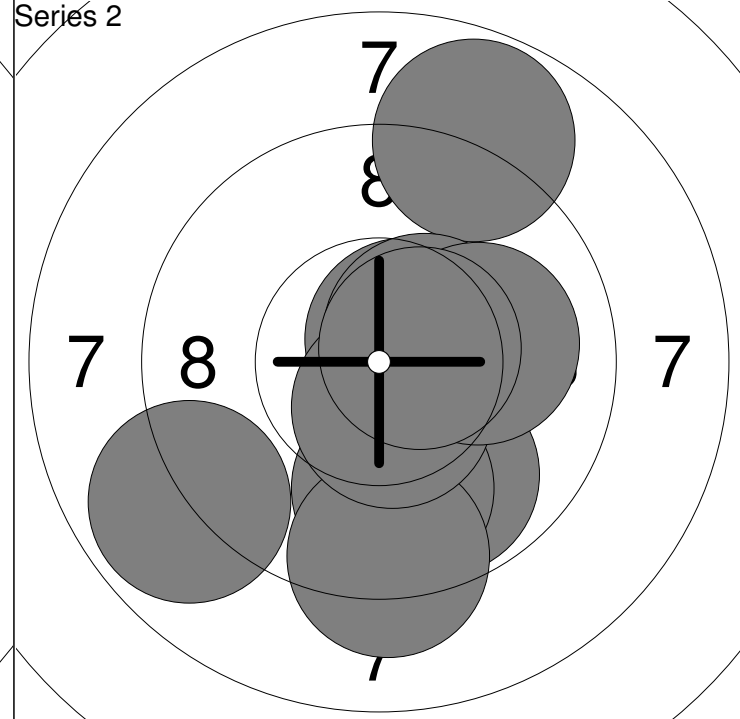
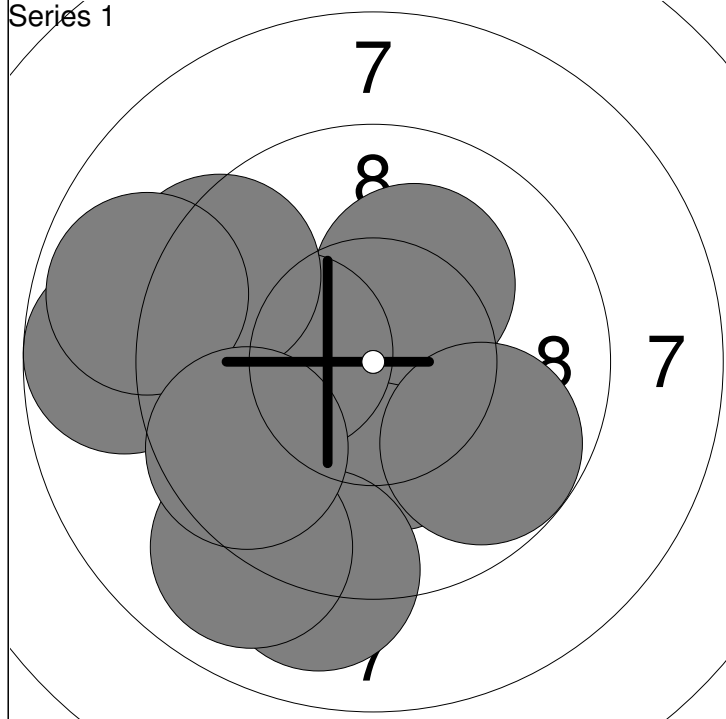

1: 10.3x ↓	6: 9.4 ↖	Series	95.0
2: 10.2x ↗	7: 8.8 ←		
3: 9.8 ↓	8: 9.0 ↓	Series	95.0
4: 10.2x ←	9: 9.0 ↓		
5: 8.7 ←	10: 9.6 ↙		

1: 9.8 ↓	6: 9.8 ↓	Series	98.6
2: 8.8 ↗	7: 9.2 ↓		
3: 10.6x ↗	8: 10.5x ↓	Series	193.6
4: 8.8 ↙	9: 10.0 →		
5: 10.5x ↗	10: 10.6x →		

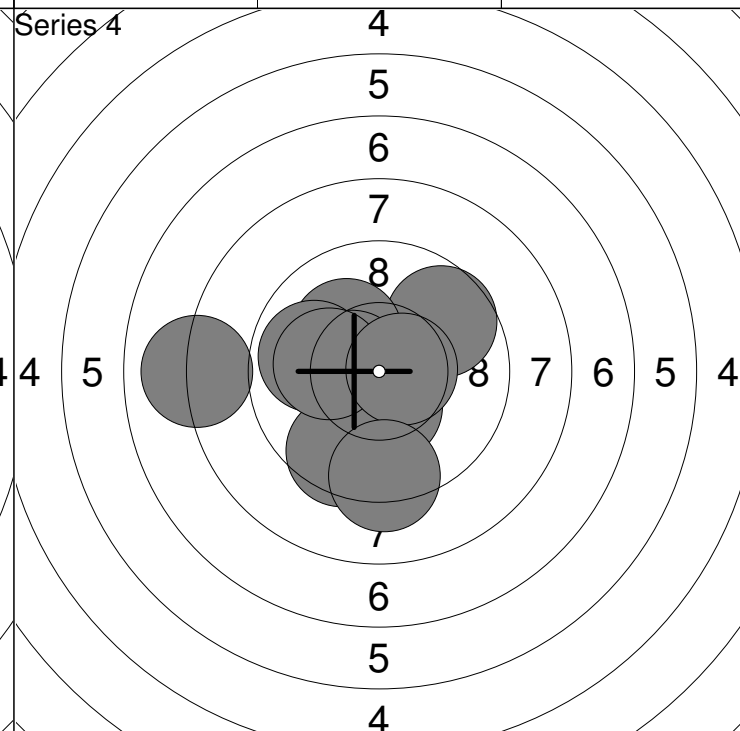
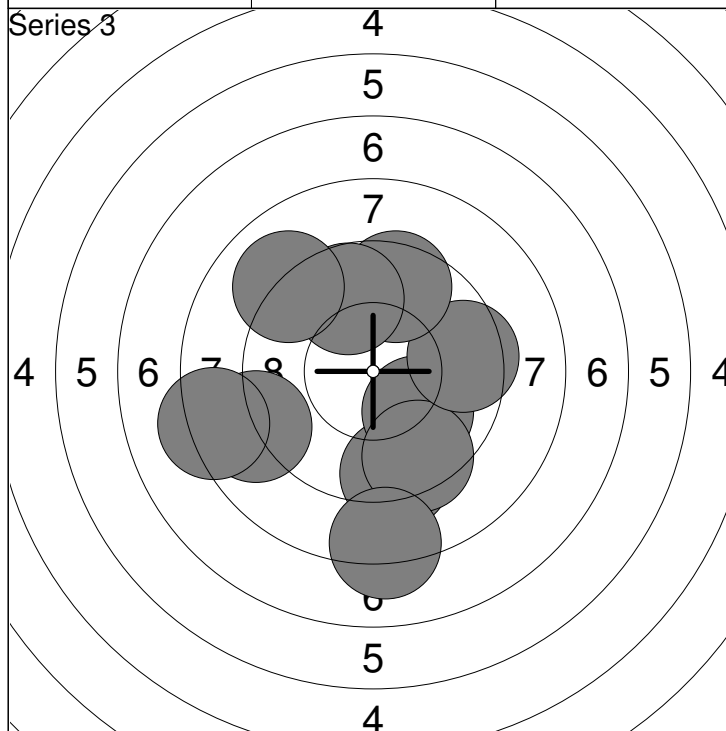

1: 8.9 ←	6: 8.2 ←	Series	91.6
2: 9.2 ↓	7: 9.5 ↗		
3: 10.0 ↓	8: 9.7 ↗	Series	285.2
4: 9.4 ↓	9: 8.2 ↓		
5: 9.5 →	10: 9.0 ↗		

1: 9.6 ↗	6: 9.9 ←	Series	97.9
2: 10.3x ↓	7: 9.5 ↓		
3: 10.1 ↗	8: 10.1 ←	Series	383.1
4: 10.5x ←	9: 10.6x →		
5: 8.0 ←	10: 9.3 ↓		

Mikkelin Ampujat ry

Relay **1** Lane **9** **Teemu Turpeinen**

10m Ilma-ase lauantai TiA M16

2.- 3.2.2019 10. Markun ilma-asekilpailu Mikkelii Shooting Club

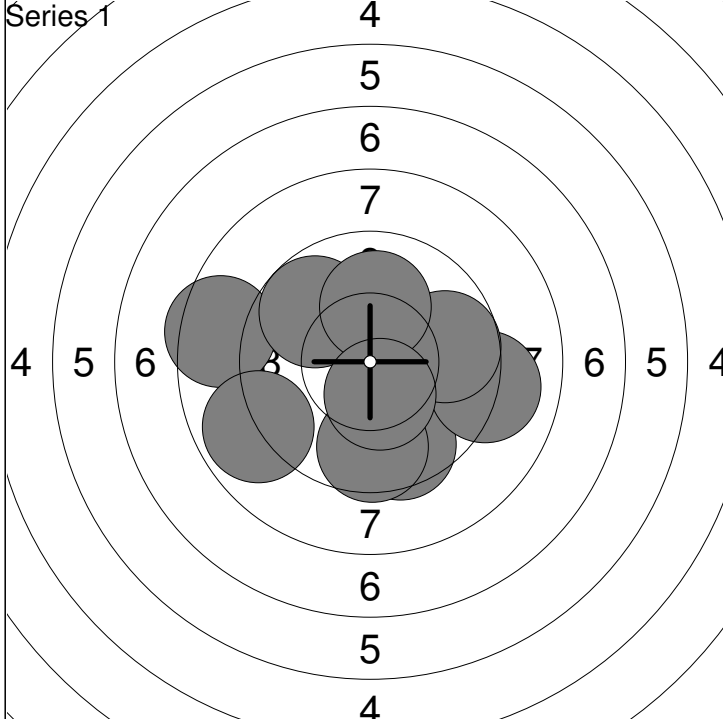

1: 8.5 ←	6: 9.7 →	Series	95.1
2: 9.8 →	7: 9.6 ↓		
3: 9.5 ↓	8: 10.0 ↑	Series	95.1
4: 9.7 ↗	9: 10.4x ↓		
5: 9.0 →	10: 8.9 ↙		

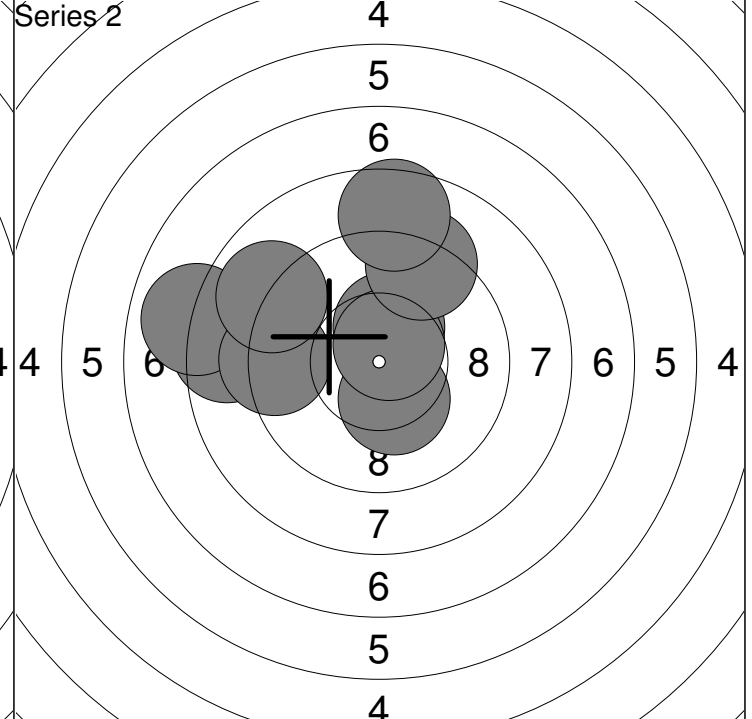

1: 10.3x ↑	6: 9.2 ↑	Series	92.6
2: 10.3x ↓	7: 7.9 ←		
3: 9.0 ←	8: 8.6 ↑	Series	187.7
4: 10.6x ↗	9: 9.3 ←		
5: 8.5 ←	10: 8.9 ↙		

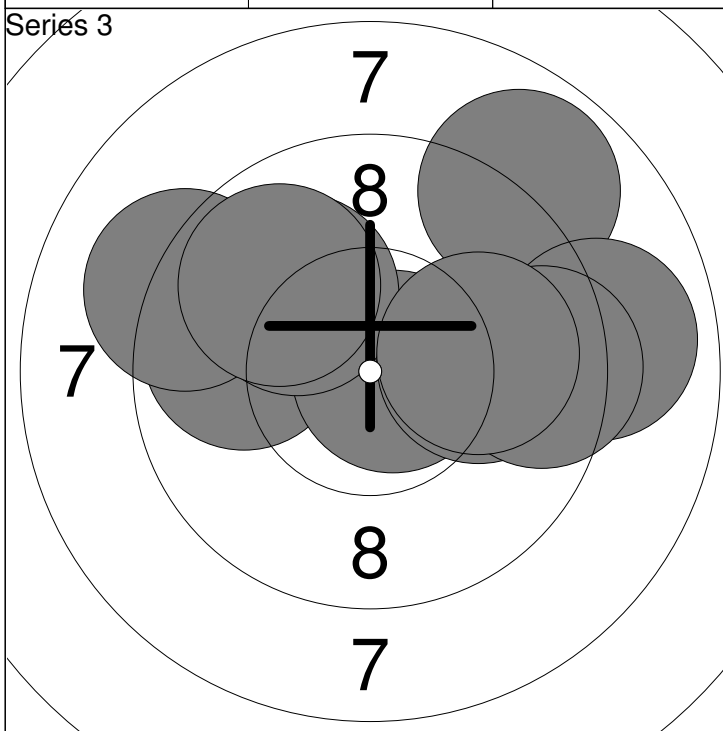

1: 8.9 ↗	6: 9.1 ↙	Series	96.5
2: 9.8 ←	7: 10.0 →		
3: 8.9 →	8: 9.4 →	Series	284.2
4: 10.7x →	9: 9.8 ↗		
5: 10.0 ↗	10: 9.9 →		

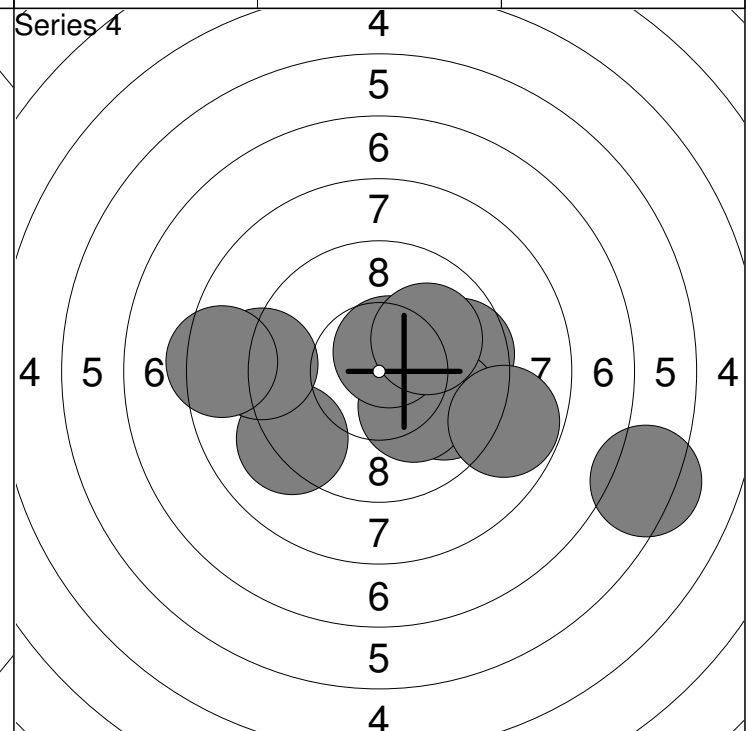

1: 9.6 →	6: 10.1 ↓	Series	91.8
2: 9.2 ↙	7: 10.6x ↑		
3: 9.8 ↘	8: 10.0 ↗	Series	376.0
4: 9.0 ←	9: 6.3 →		
5: 8.4 ←	10: 8.8 →		

Mikkelin Ampujat ry

Series 1

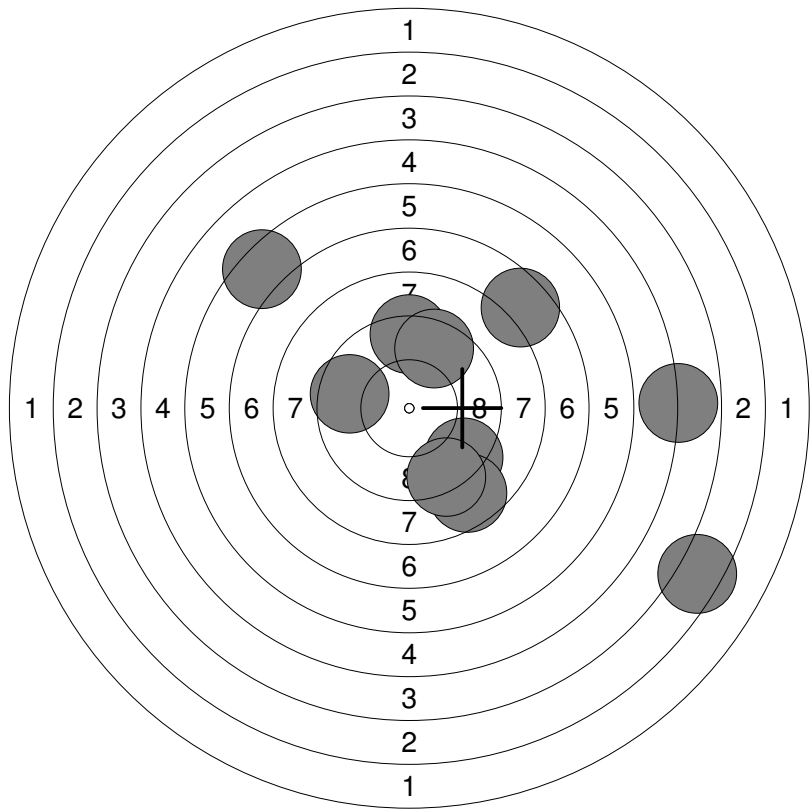

1:	9.2	↑
2:	7.5	↗
3:	9.4	↗
4:	6.3	↗
5:	9.3	↘
6:	8.6	↘
7:	9.1	↘
8:	9.5	←
9:	4.8	→
10:	3.3	↘

Series	73
	73

Series 2

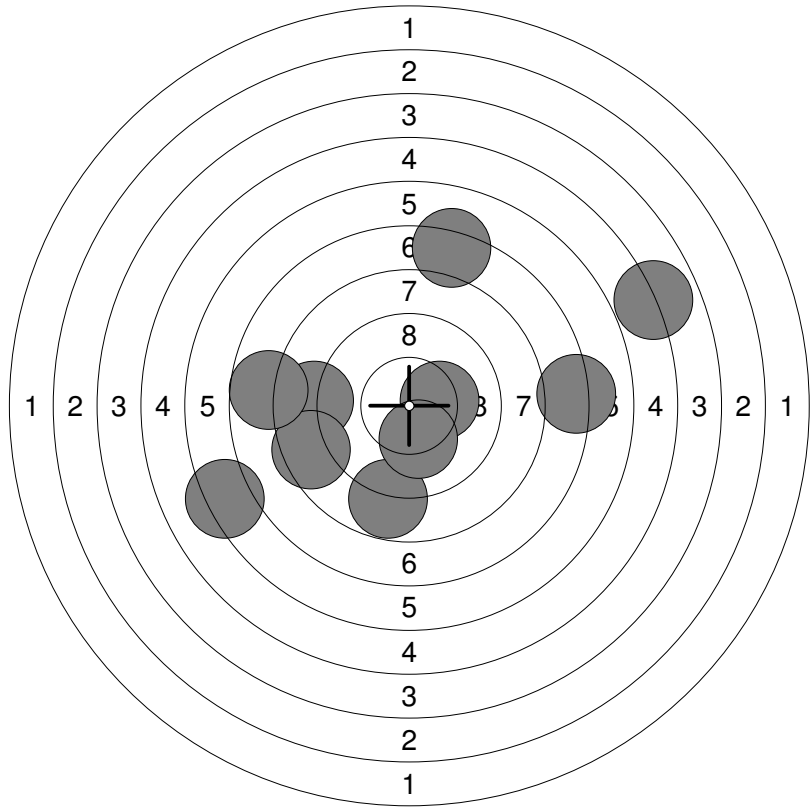

1:	10.2x	→
2:	8.7	↓
3:	8.8	←
4:	10.1	↓
5:	4.9	↗
6:	6.2	←
7:	7.2	↑
8:	7.1	→
9:	8.5	←
10:	7.7	←

Series	75
	148

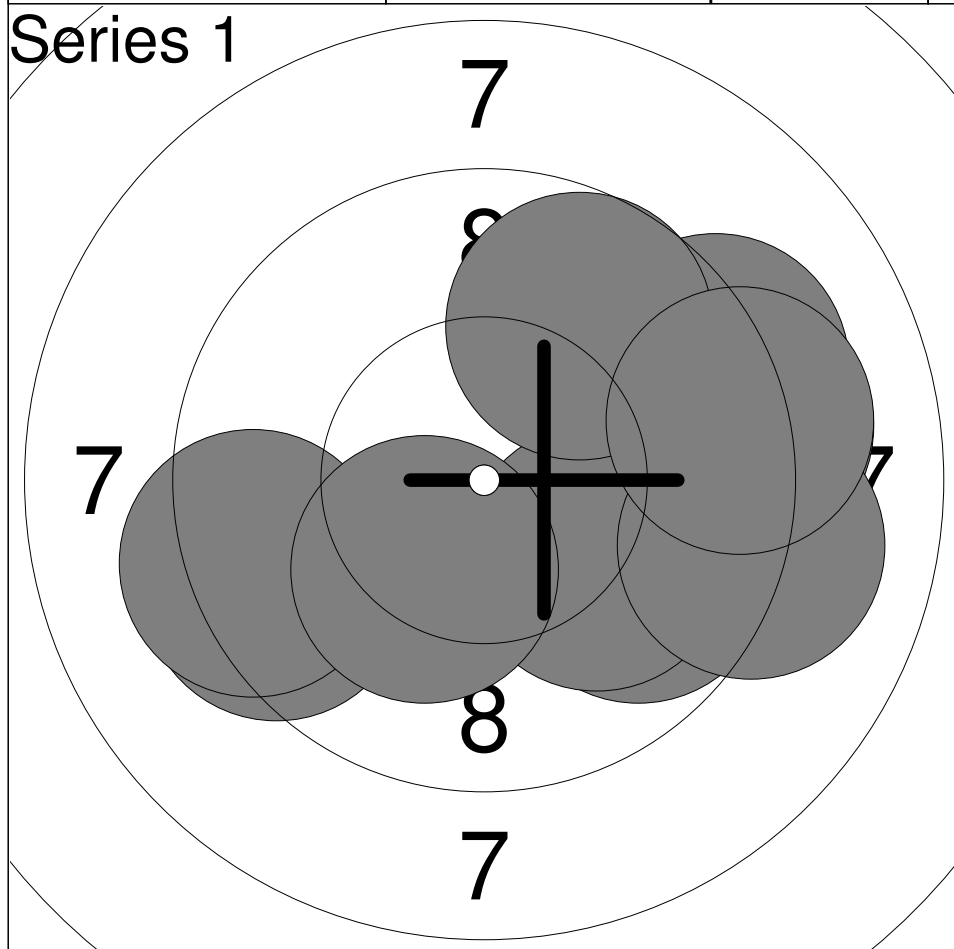

1:	9.2	→
2:	9.7	↘
3:	10.0	↘
4:	9.3	↙
5:	9.3	↙
6:	9.2	↗
7:	9.7	↗
8:	10.2x	↘
9:	9.1	→
10:	9.1	→

Series	92
	92

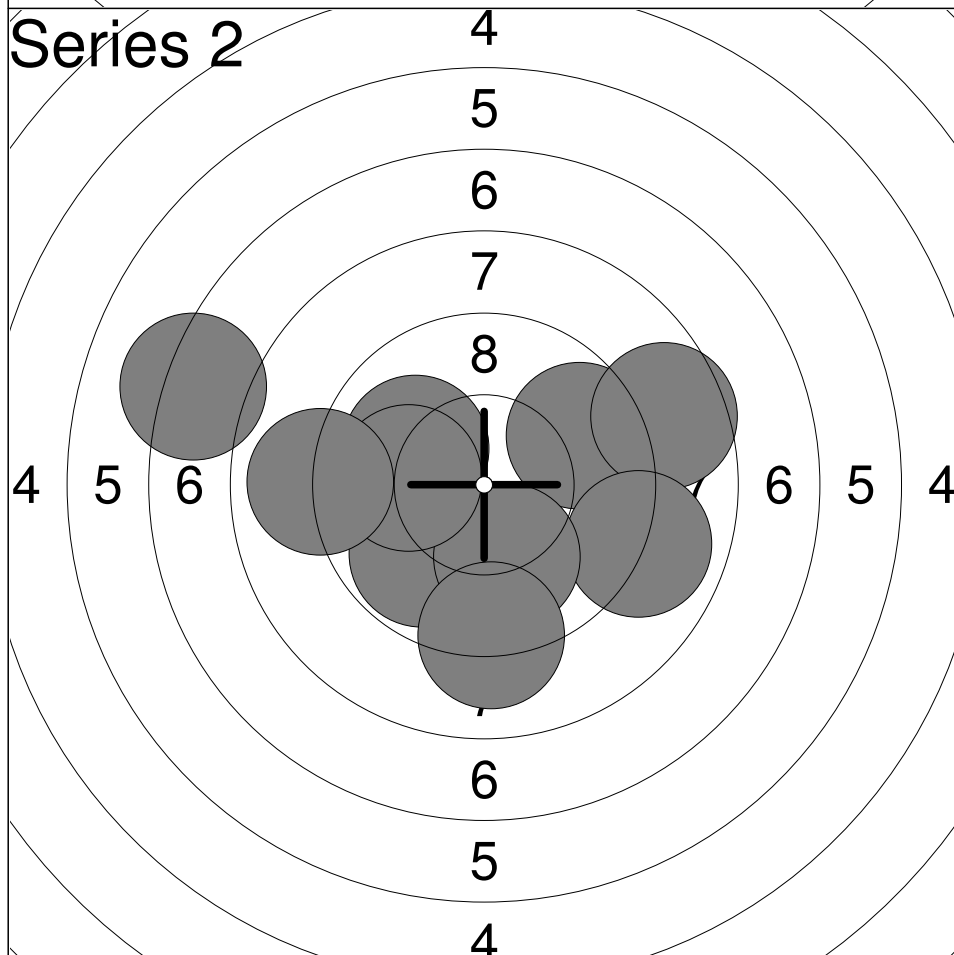

1:	9.6	↗
2:	9.8	↘
3:	10.0	↗
4:	8.5	↗
5:	8.9	↘
6:	10.0	↘
7:	7.2	↖
8:	9.1	↘
9:	10.0	↖
10:	8.9	↖

Series	88
	180

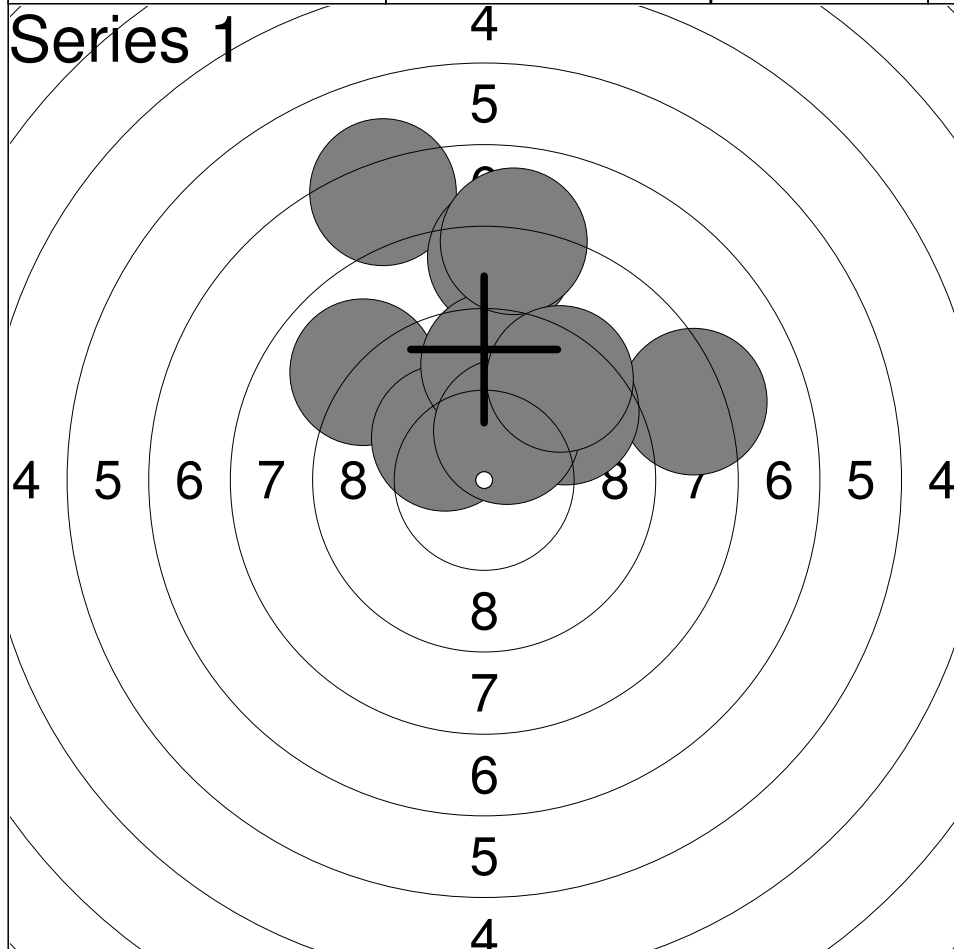

1:	8.9	↖
2:	7.2	↑
3:	10.2x	↖
4:	8.2	↑
5:	9.5	↑
6:	8.0	↑
7:	8.2	→
8:	9.6	↗
9:	10.3x	↑
10:	9.4	↗

Series	86
	86

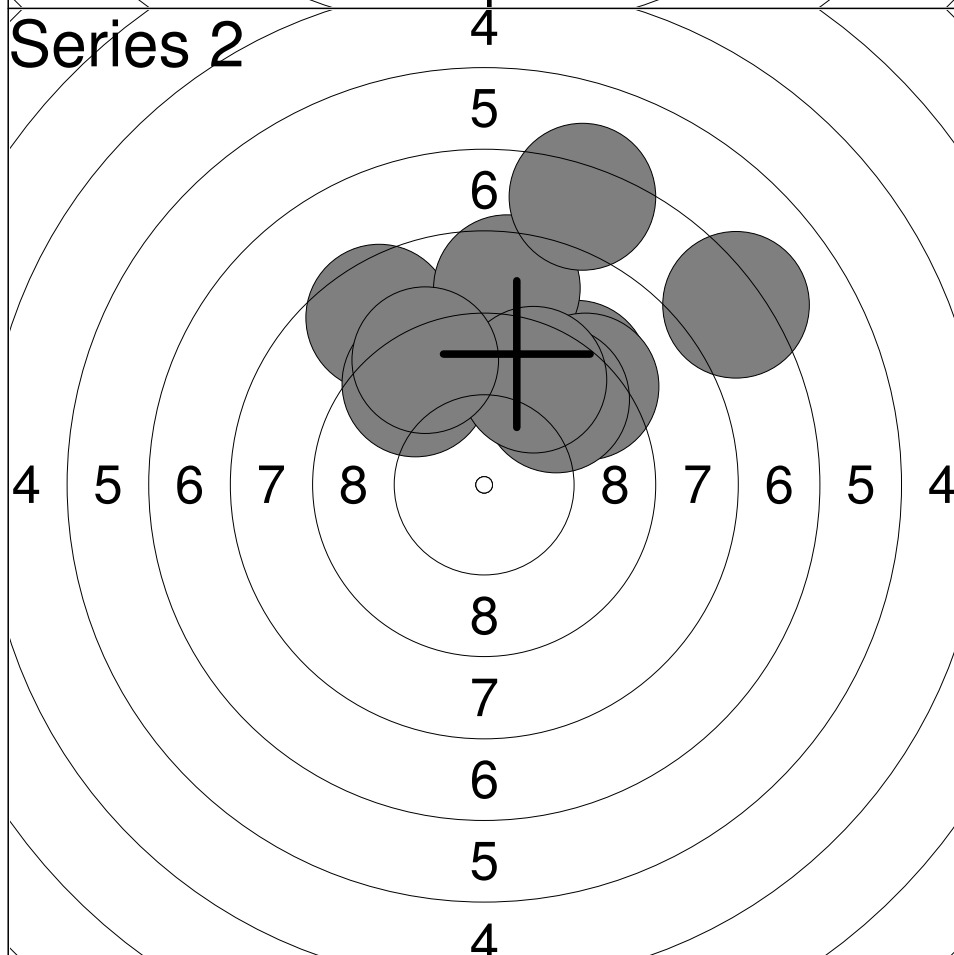

1:	9.1	↗
2:	8.5	↖
3:	8.5	↑
4:	9.2	↗
5:	9.4	↖
6:	7.2	↑
7:	9.6	↗
8:	9.5	↑
9:	7.1	↗
10:	9.2	↑

Series	84
	170

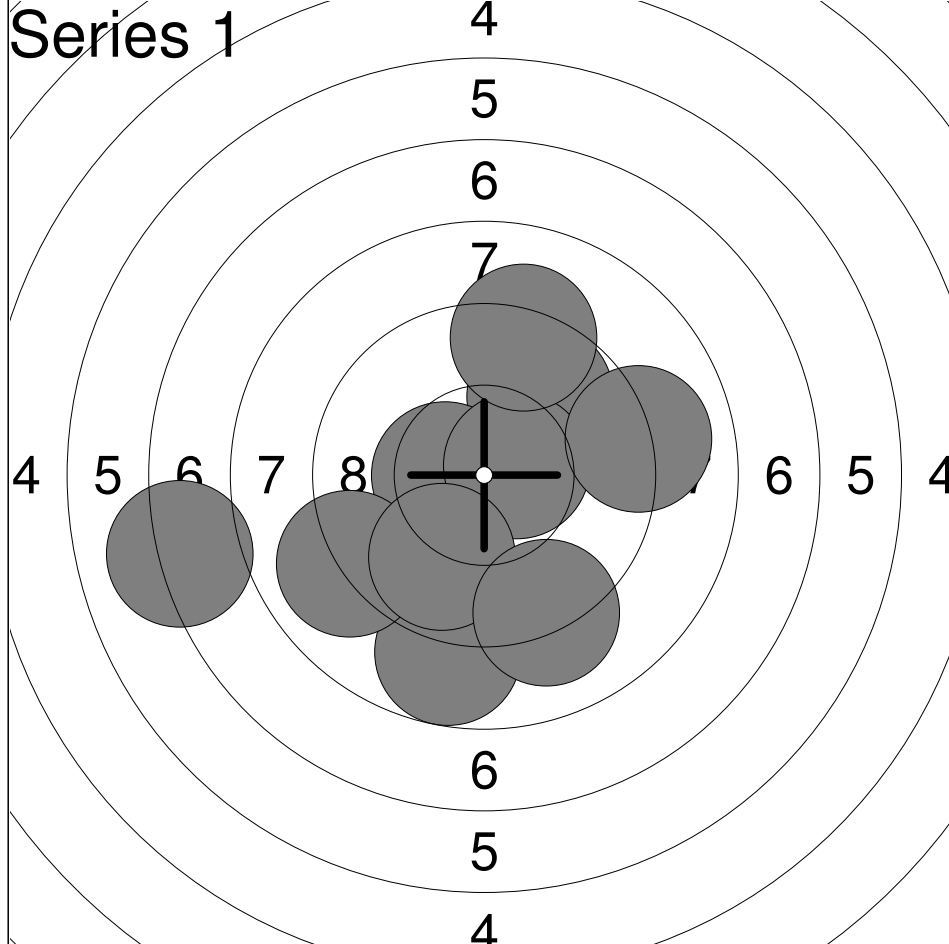

1:	9.8	↗
2:	10.5x	←
3:	10.5x	→
4:	9.0	→
5:	8.7	↓
6:	9.2	↑
7:	9.0	↙
8:	9.8	↘
9:	7.1	←
10:	9.1	↘

Series	89
	89

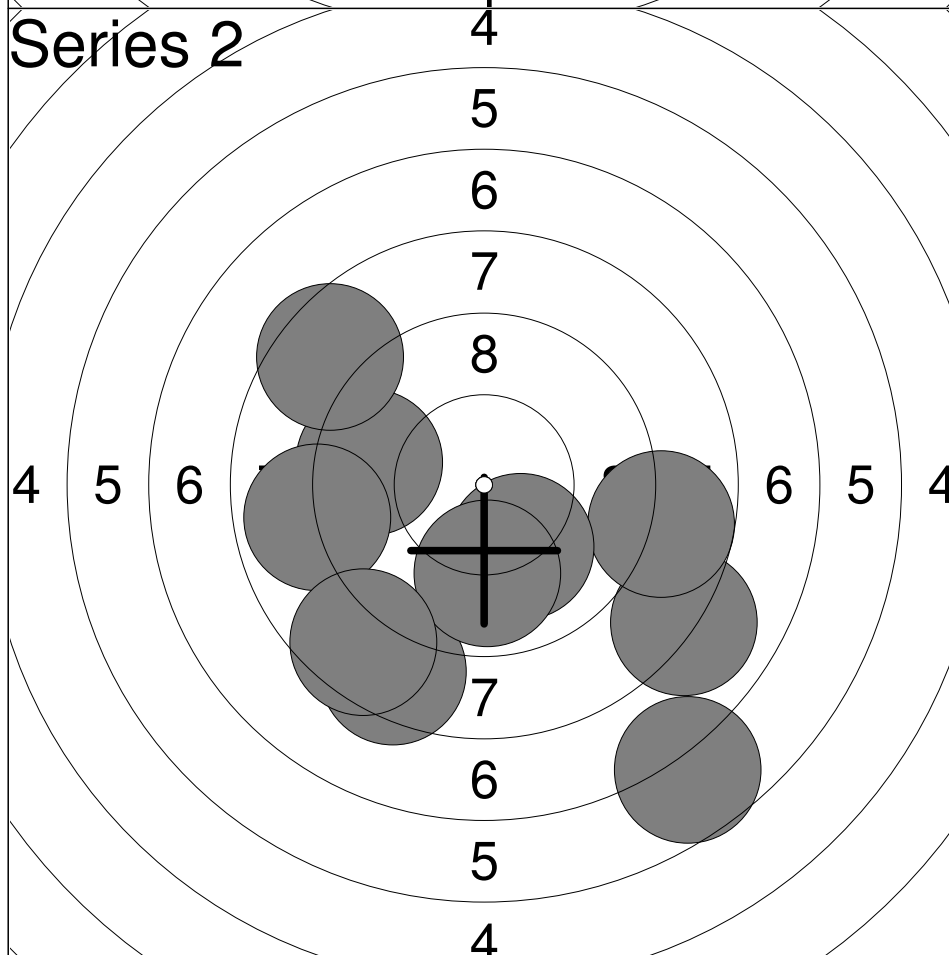

1:	9.5	←
2:	6.6	↘
3:	7.9	↘
4:	8.5	↗
5:	8.4	↘
6:	8.7	→
7:	8.8	←
8:	10.1	↘
9:	9.8	↓
10:	8.5	↙

Series	81
	170

Series 1

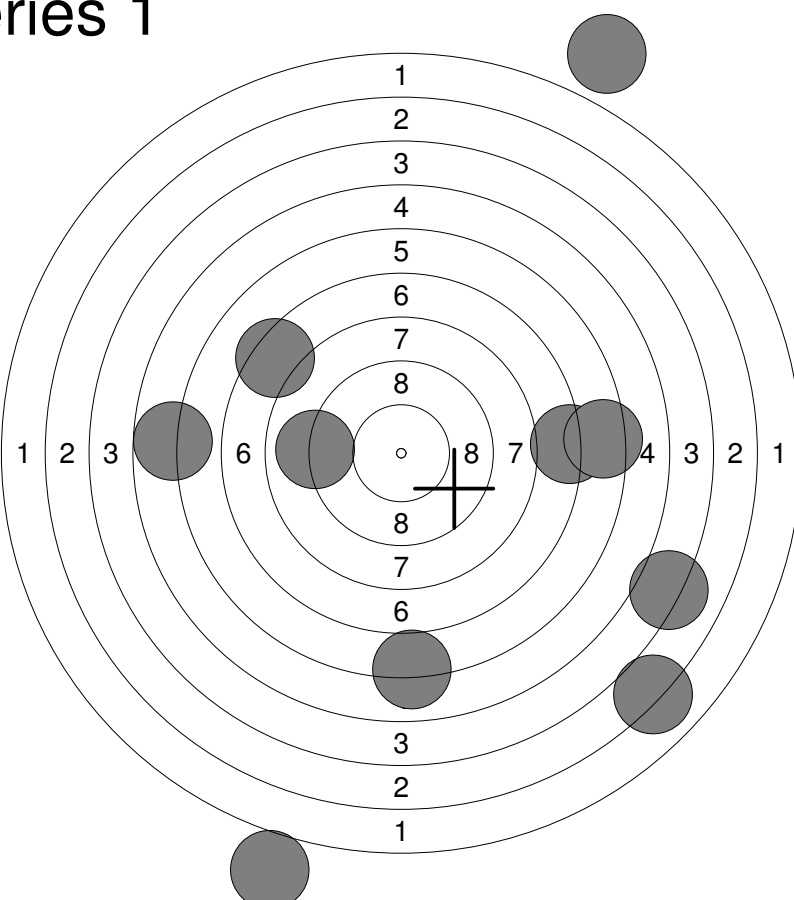

1:	4.1	↘
2:	7.3	↗
3:	0.0	↗
4:	1.0	↘
5:	7.1	→
6:	3.0	↘
7:	6.3	→
8:	5.7	←
9:	6.0	↘
10:	9.0	←

Series	48
	48

Series 2

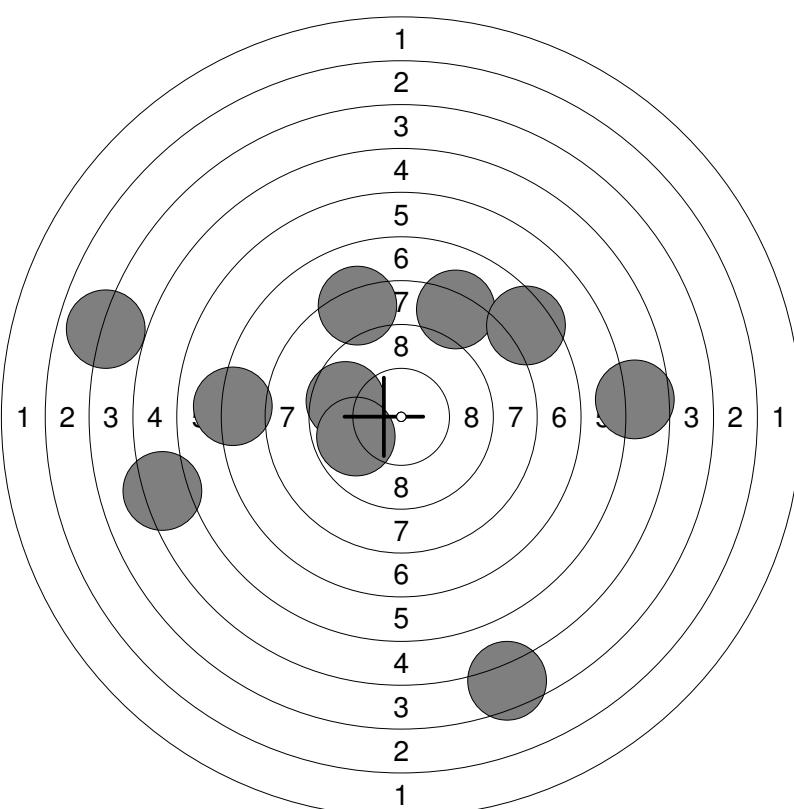

1:	4.5	↘
2:	8.2	↗
3:	5.6	→
4:	9.6	←
5:	3.9	←
6:	5.2	←
7:	8.2	↗
8:	7.1	←
9:	9.8	←
10:	7.4	↗

Series	65
	113

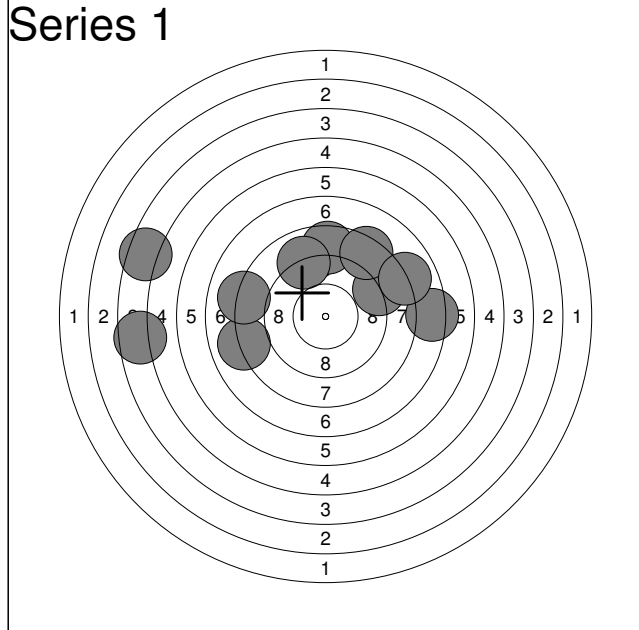

1:	8.9	↗
2:	8.6	↑
3:	7.3	→
4:	8.0	←
5:	8.9	↑
6:	4.6	←
7:	4.4	←
8:	8.1	←
9:	8.3	↗
10:	7.9	↗
Series		70
		70

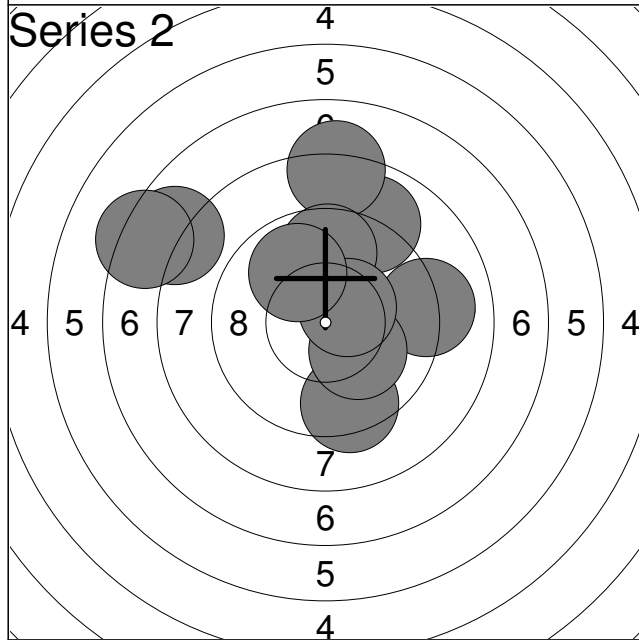

1:	8.9	↗
2:	8.1	↑
3:	9.4	↓
4:	9.7	↑
5:	7.7	↖
6:	7.3	←
7:	9.1	→
8:	10.2x	↘
9:	10.4x	↗
10:	9.9	↑
Series		86
		156

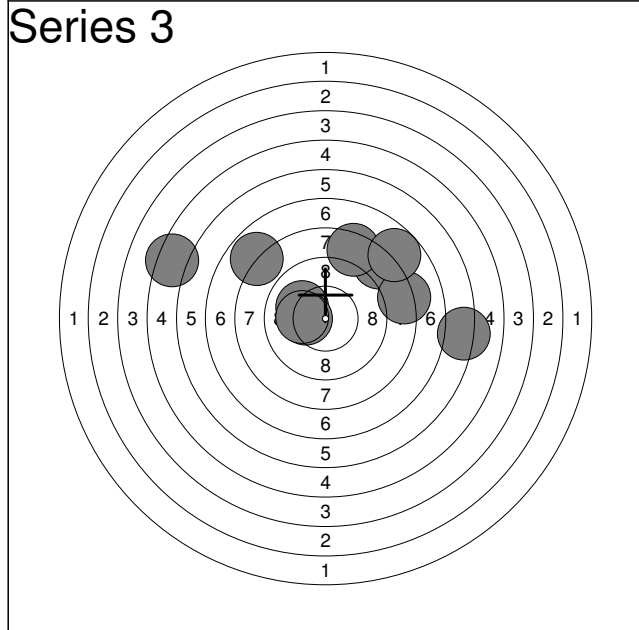

1:	8.3	↗
2:	10.1	←
3:	8.2	→
4:	10.3x	←
5:	6.2	→
6:	5.3	←
7:	8.4	↗
8:	10.1	←
9:	7.7	↗
10:	7.8	↖
Series		79
		235

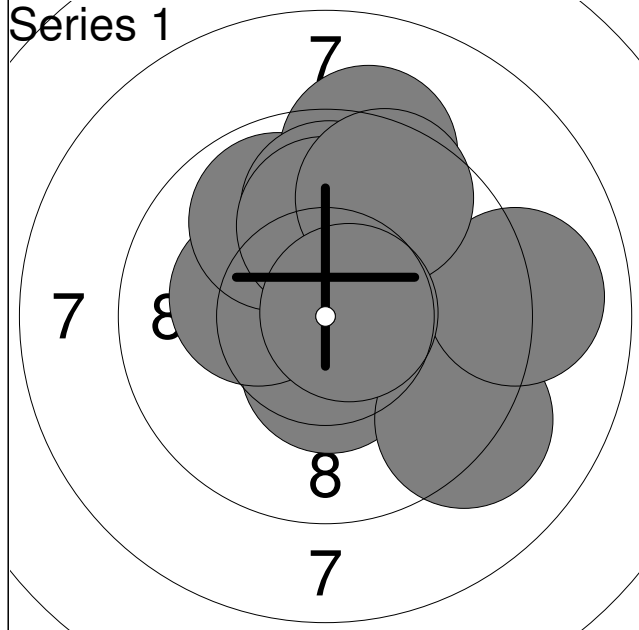

1:	10.4x	↓
2:	9.2	↘
3:	10.2x	←
4:	9.0	→
5:	9.9	↗
6:	9.2	↑
7:	9.9	↑
8:	10.0	↑
9:	9.6	↗
10:	10.7x	→
Series		94
		94

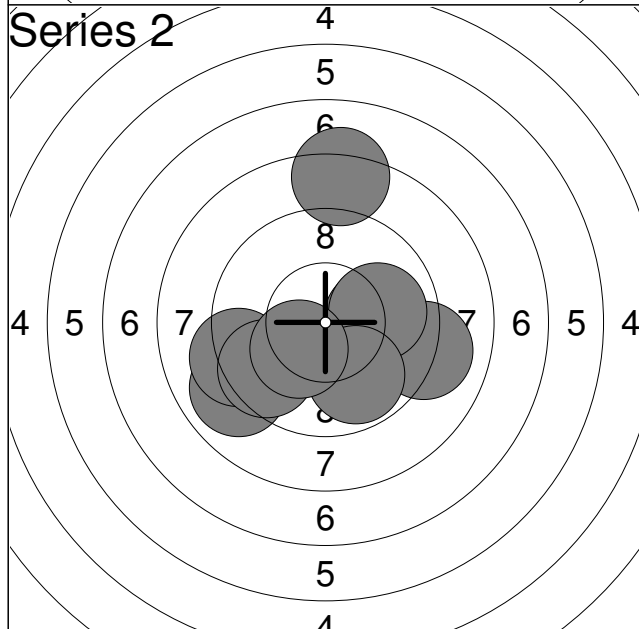

1:	8.9	↙
2:	9.2	↙
3:	9.5	↙
4:	10.0	→
5:	10.1	↘
6:	8.2	↑
7:	9.0	→
8:	9.9	→
9:	9.8	↘
10:	10.2x	↙
Series		91
		185

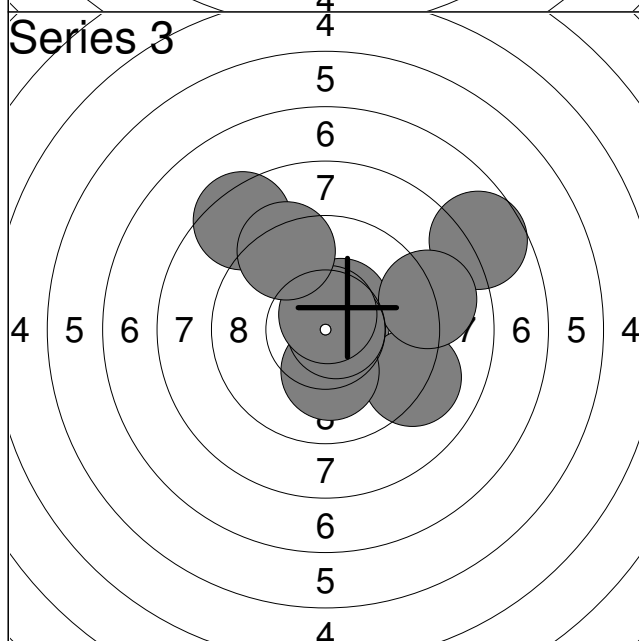

1:	10.6x	→
2:	9.1	↘
3:	10.4x	↗
4:	7.7	↗
5:	10.2x	↓
6:	9.0	→
7:	8.4	↗
8:	10.7x	→
9:	10.6x	↑
10:	9.3	↗
Series		92
		277

Relay	Lane	Jari Gusev		
3	1	Jari Gusev		
10m Ilma-ase lauantai		PAS	R11 Y	
2.- 3.2.2019		10. Markun ilma-asekilpailu	Mikkeli Shooting Club	
Series 1		1: 9.6 → 2: 8.6 → 3: 8.0 → 4: 8.0 ↗ 5: 10.1 → 6: 9.3 ↘ 7: 9.7 ↗ 8: 9.1 → 9: 10.5x → 10: 9.1 → Series 92.0 92.0	Series 2 	1: 9.1 → 2: 10.3x → 3: 10.5x → 4: 9.1 ↗ 5: 9.5 ↗ 6: 10.3x ↗ 7: 9.3 ↘ 8: 9.2 → 9: 7.9 ↘ 10: 10.2x ↘ Series 95.4 187.4
Series 3		1: 10.8x → 2: 8.0 ↗ 3: 9.3 → 4: 8.4 → 5: 9.6 → 6: 9.5 ↗ 7: 10.2x → 8: 10.3x → 9: 9.6 → 10: 10.3x ← Series 96.0 283.4	Series 4 	1: 10.5x ↗ 2: 3.5 ↗ 3: 7.8 ← 4: 7.4 ↑ 5: 9.9 ← 6: 9.3 ↘ 7: 8.3 ← 8: 9.0 ← 9: 10.7x ↗ 10: 10.3x ← Series 86.7 370.1
Series 5		1: 9.9 ← 2: 9.9 ↘ 3: 7.4 ↗ 4: 8.3 ↗ 5: 9.4 ↗ 6: 8.3 ↗ 7: 9.7 ↗ 8: 8.5 ↗ 9: 8.7 ↗ 10: 8.3 ↗ Series 88.4 458.5	Series 6 	1: 10.6x ↗ 2: 8.7 ↗ 3: 9.6 ↘ 4: 9.1 ↑ 5: 8.8 ← 6: 10.1 ← 7: 9.8 ↘ 8: 10.3x ← 9: 9.3 ↗ 10: 5.5 ↑ Series 91.8 550.3

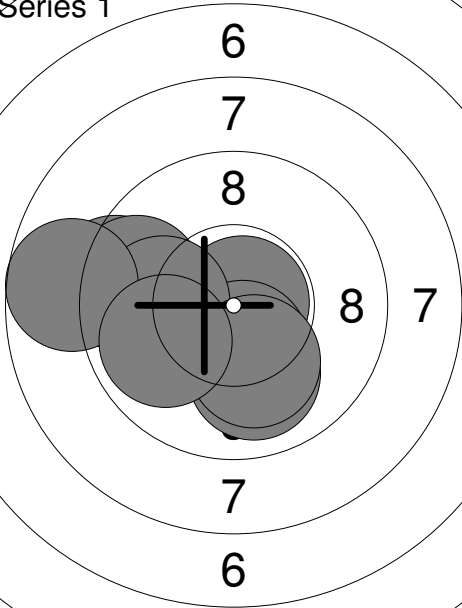
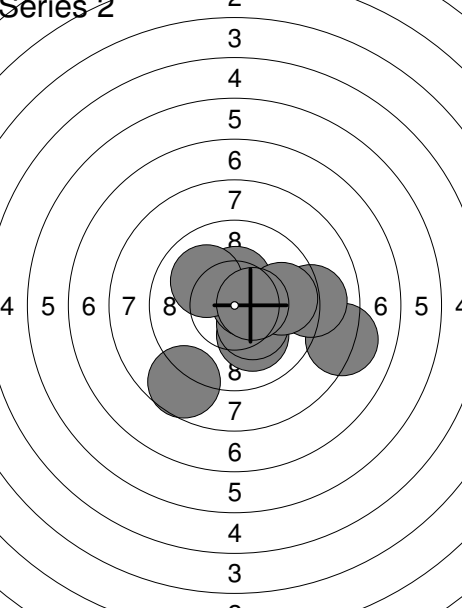
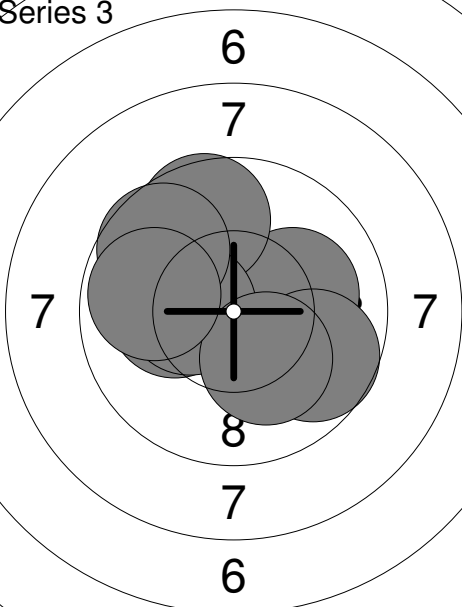
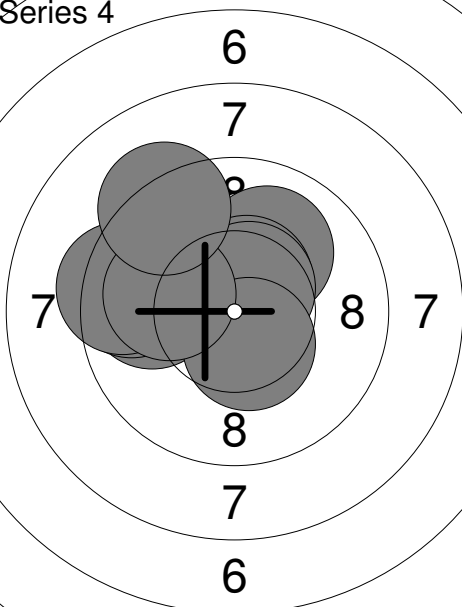
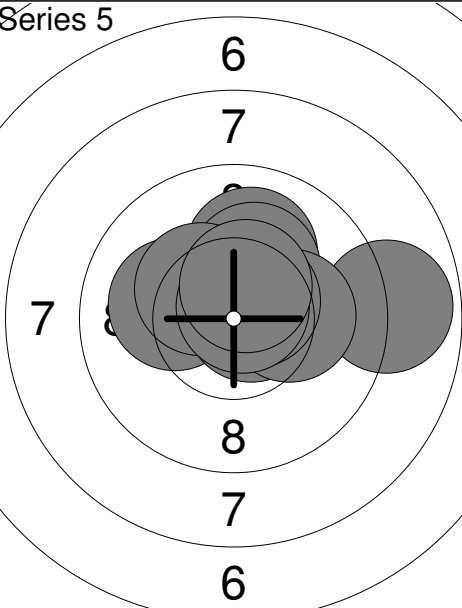
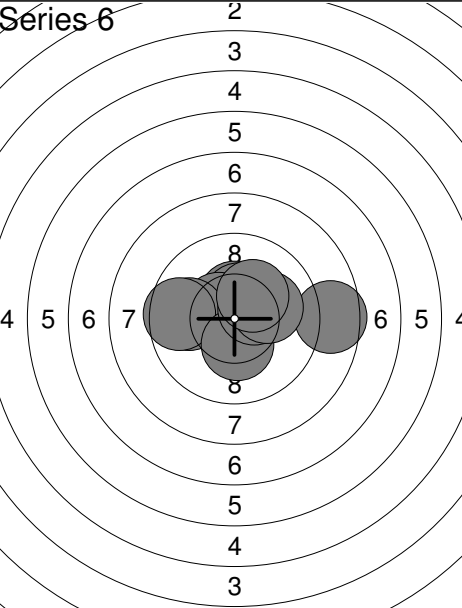
Relay	Lane	Timo Nyström		
3	2	10m Ilma-ase launtai	MA	R11 Y
2.- 3.2.2019		10. Markun ilma-asekilpailu		Mikkeli Shooting Club
Series 1		1: 9.9 ← 2: 10.8x → 3: 10.4x ↓ 4: 9.3 ← 5: 9.6 ← 6: 10.0 ↓ 7: 10.0 ← 8: 10.1 ↓ 9: 8.7 ← 10: 9.9 ← Series 98.7 98.7	Series 2	 1: 10.1 ↓ 2: 8.7 ↓ 3: 8.1 → 4: 9.1 → 5: 10.3x ↓ 6: 10.6x → 7: 10.4x ↑ 8: 10.0 ↖ 9: 9.7 → 10: 10.5x → Series 97.5 196.2
Series 3		1: 10.1 ← 2: 10.1 → 3: 9.7 ↘ 4: 10.0 ← 5: 9.6 ↑ 6: 10.1 ← 7: 10.3x ← 8: 10.2x ↓ 9: 9.6 ↗ 10: 9.8 ← Series 99.5 295.7	Series 4	 1: 10.0 ↗ 2: 9.8 ← 3: 10.5x ↗ 4: 9.8 ← 5: 10.5x ↗ 6: 9.5 ← 7: 9.4 ← 8: 10.5x ↓ 9: 10.0 ← 10: 9.2 ↗ Series 99.2 394.9
Series 5		1: 10.0 ↑ 2: 10.1 ← 3: 10.2x ↗ 4: 10.3x ↖ 5: 10.7x → 6: 8.9 → 7: 10.2x → 8: 10.5x ↗ 9: 10.7x ↗ 10: 10.5x ↗ Series 102.1 497.0	Series 6	 1: 10.4x ↑ 2: 10.4x ↑ 3: 10.5x ↖ 4: 9.8 ← 5: 9.6 ← 6: 8.6 → 7: 10.3x ↓ 8: 10.4x → 9: 10.1 → 10: 10.2x ↗ Series 100.3 597.3

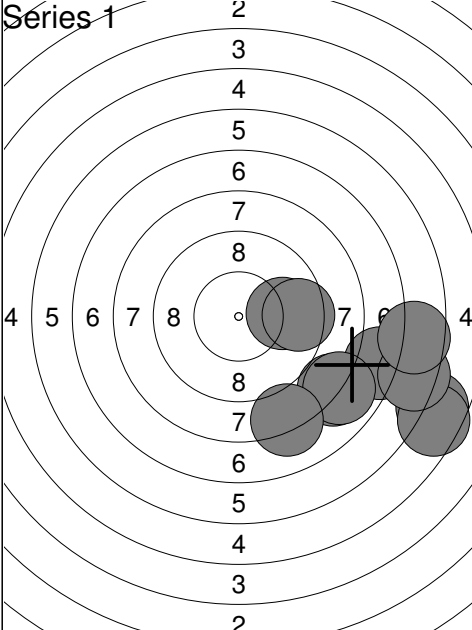
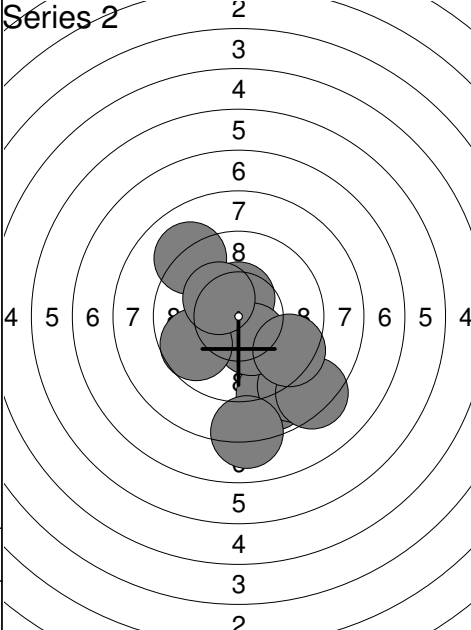
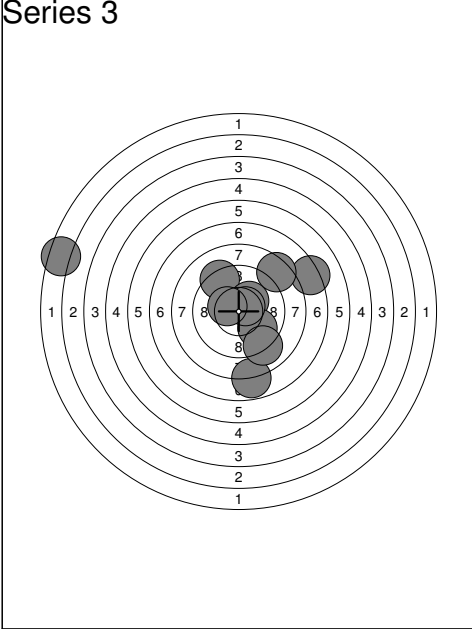
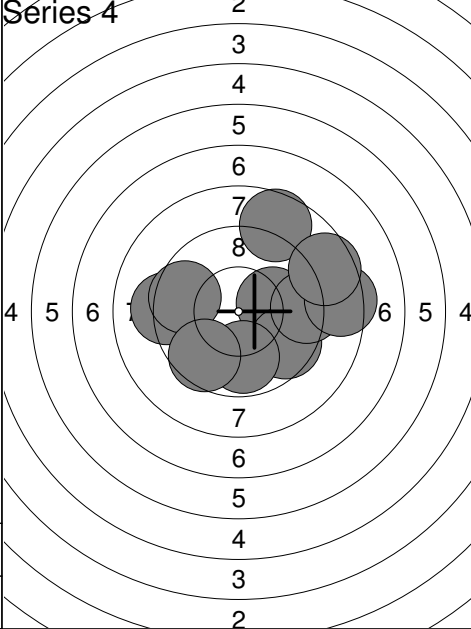
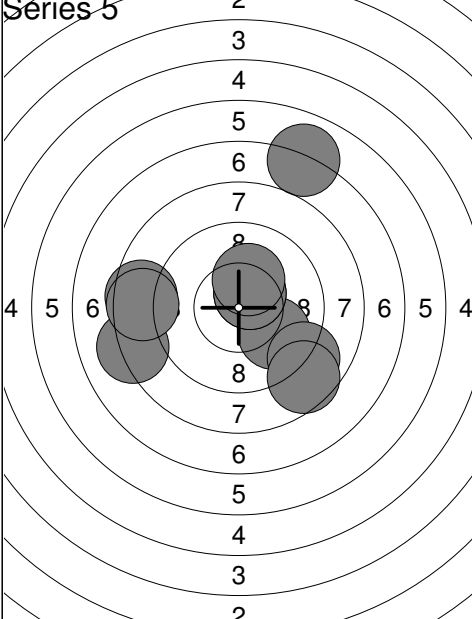
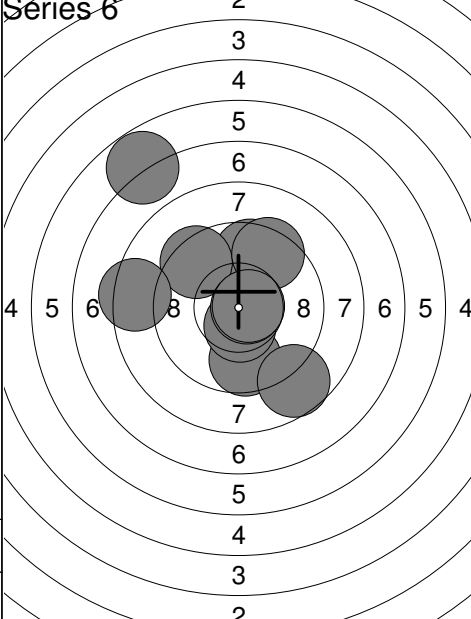
Relay 3	Lane 3	Mikael Toivainen			
10m Ilma-ase lauantai		VS-VA	R11 Y		
2.- 3.2.2019		10. Markun ilma-asekilpailu	Mikkeli Shooting Club		
Series 1		1: 7.2 → 2: 8.0 ↘ 3: 9.9 → 4: 7.9 ↘ 5: 5.7 ↘ 6: 5.5 ↘ 7: 9.4 → 8: 6.4 → 9: 6.6 → 10: 8.1 ↘	Series 2		1: 10.5x ↑ 2: 8.8 ↘ 3: 8.7 ↘ 4: 8.1 ↘ 5: 8.3 ↘ 6: 10.3x ↘ 7: 9.1 ↗ 8: 9.7 ↙ 9: 10.3x ↗ 10: 9.4 ↘
Series		74.7	Series		93.2
		74.7			167.9
Series 3		1: 9.2 ↗ 2: 7.2 ↗ 3: 10.2x ↗ 4: 8.4 ↗ 5: 9.8 ↘ 6: 10.5x ↗ 7: 7.8 ↘ 8: 2.4 ← 9: 10.4x ↙ 10: 9.0 ↘	Series 4		1: 10.1 → 2: 9.2 ← 3: 9.5 ← 4: 9.5 ↘ 5: 9.8 ↘ 6: 9.5 ↘ 7: 8.6 ↗ 8: 9.2 → 9: 8.4 → 10: 8.6 ↗
Series		84.9	Series		92.4
		252.8			345.2
Series 5		1: 9.9 ↘ 2: 10.5x ↗ 3: 6.9 ↗ 4: 10.5x ↗ 5: 8.1 ← 6: 10.2x ↗ 7: 8.9 ↘ 8: 8.6 ↘ 9: 8.5 ← 10: 8.6 ←	Series 6		1: 9.6 ↘ 2: 8.7 ↘ 3: 10.5x ↘ 4: 9.6 ↗ 5: 9.4 ↗ 6: 10.7x → 7: 8.3 ← 8: 6.8 ↗ 9: 9.4 ↗ 10: 10.7x →
Series		90.7	Series		93.7
		435.9			529.6

Mikkelin Ampujat ry

Relay **3** Lane **4** **Hannu Jauhiainen**

10m Ilma-ase lauantai SySi M60p

2.- 3.2.2019 10. Markun ilma-asekilpailu Mikkelii Shooting Club

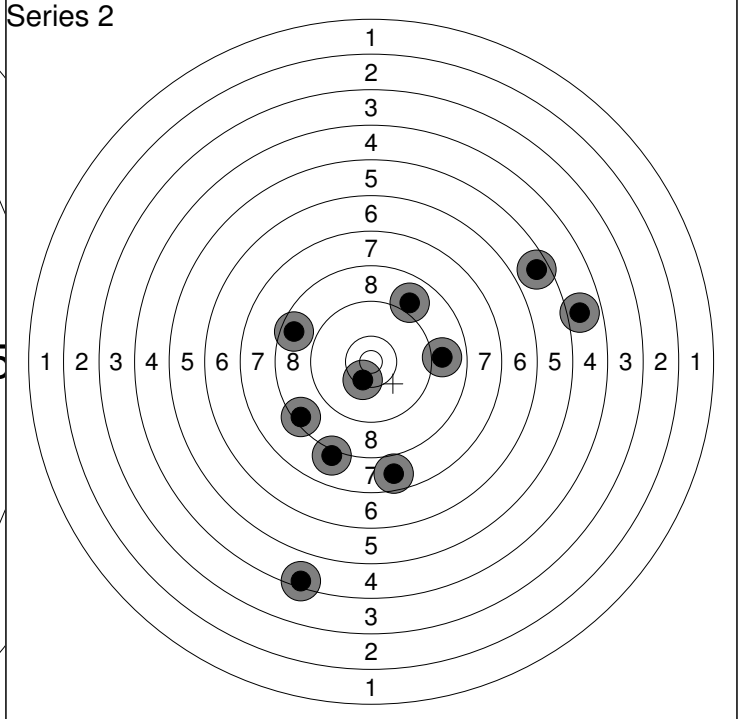
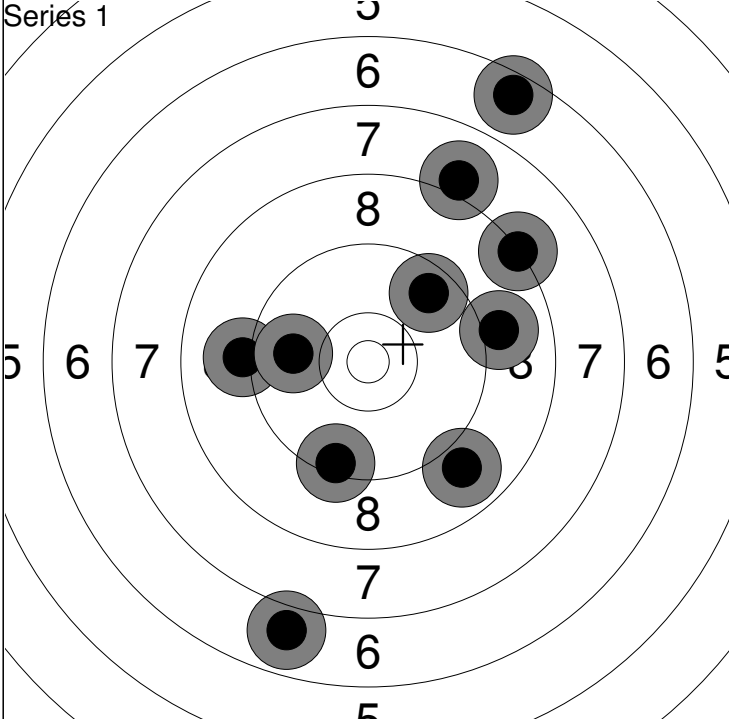

1: 9.4 ↓	6: 9.6 ↗	Series	81
2: 6.5 ↗	7: 8.2 ↗		
3: 6.9 ↓	8: 8.9 ↓	Series	81
4: 8.0 ↗	9: 9.9 ←		
5: 9.1 ←	10: 9.0 →		

1: 8.4 ↙	6: 7.7 ↓	Series	70
2: 4.9 →	7: 8.9 →		
3: 5.6 ↗	8: 10.4x ↓	Series	151
4: 8.1 ↓	9: 8.6 ←		
5: 8.9 ↗	10: 4.4 ↓		

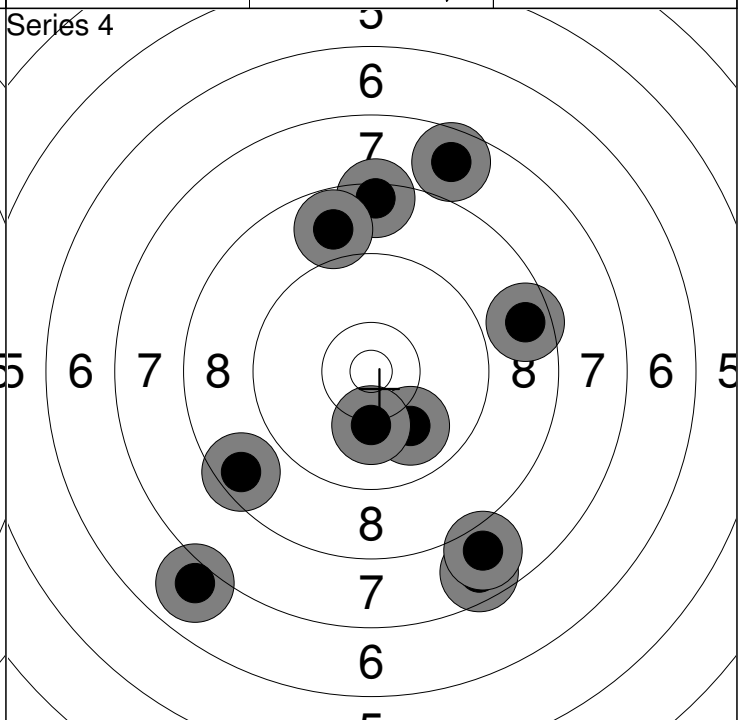
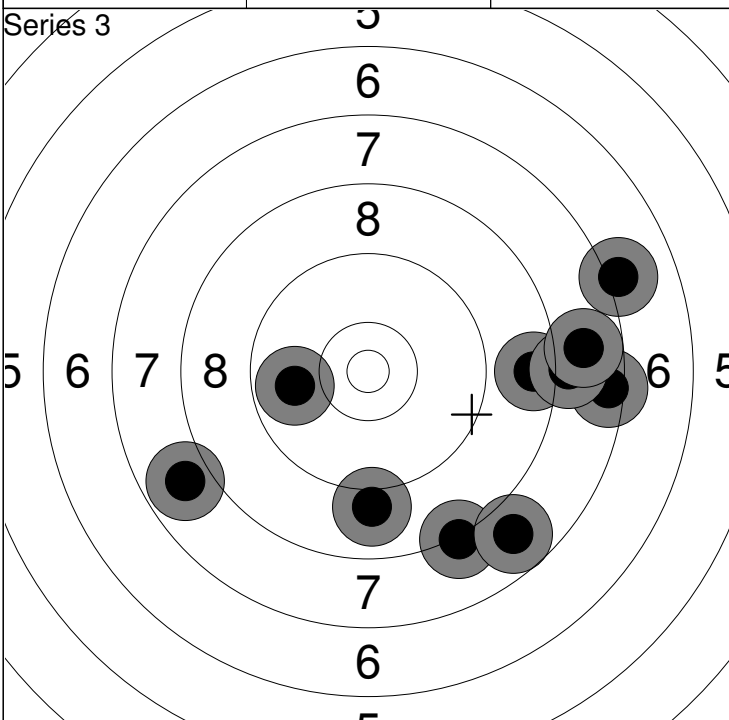

1: 8.5 →	6: 9.9 ←	Series	77
2: 7.4 →	7: 8.0 →		
3: 8.2 ↓	8: 7.8 →	Series	228
4: 7.8 ←	9: 7.8 ↓		
5: 9.0 ↓	10: 7.1 →		

1: 8.4 ↑	6: 10.0 ↓	Series	79
2: 8.6 ↙	7: 6.9 ↙		
3: 7.7 ↗	8: 10.2 ↓	Series	307
4: 8.8 ↑	9: 7.6 ↓		
5: 8.6 →	10: 7.9 ↓		

Mikkelin Ampujat ry

Relay **3** Lane **5** **Veikko Marttinen**

10m Ilma-ase lauantai PiekSA Y70p

2.- 3.2.2019 10. Markun ilma-asekilpailu Mikkelii Shooting Club

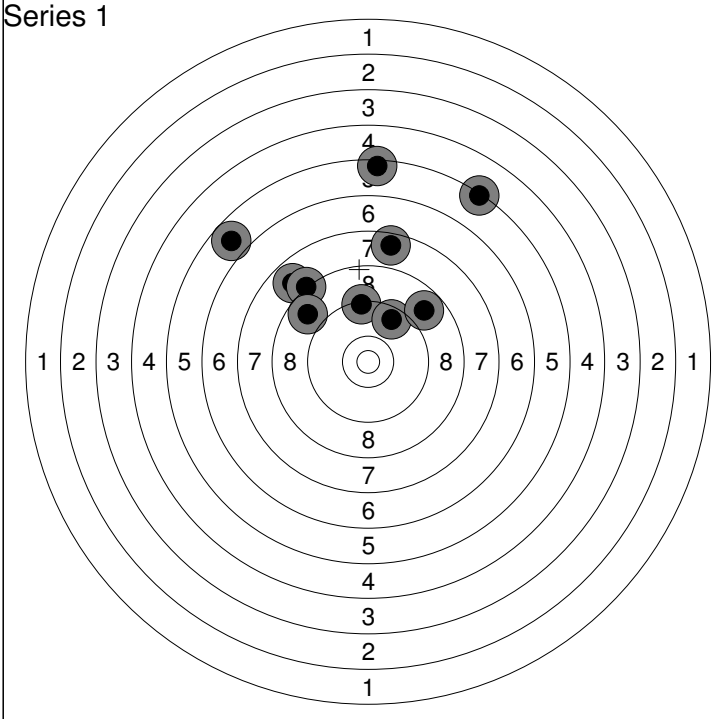

1: 5.3 ↗	6: 5.8 ↖	Series	71
2: 7.6 ↑	7: 8.2 ↗		
3: 9.3 ↑	8: 9.6 ↗	Series	71
4: 5.4 ↑	9: 8.8 ↗		
5: 7.8 ↖	10: 8.8 ↖		

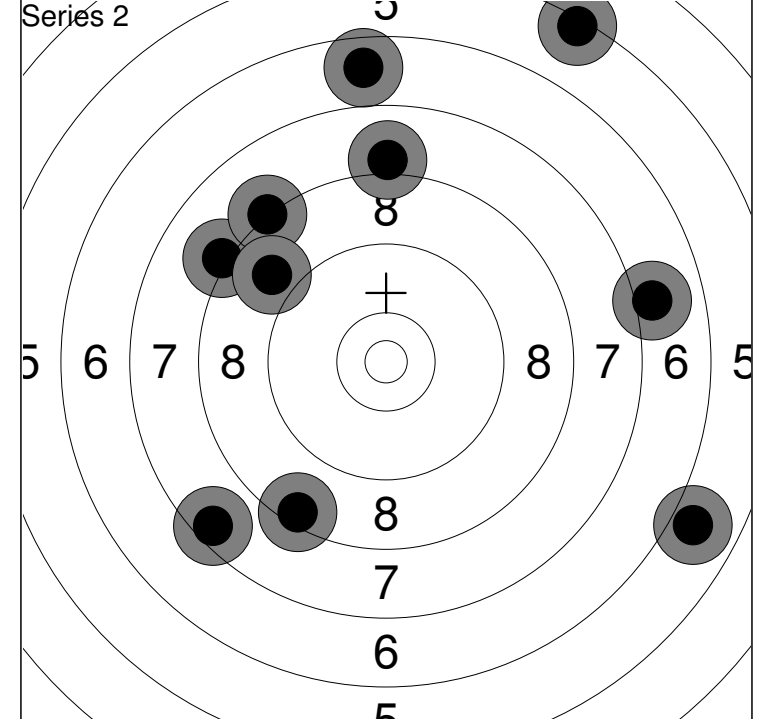

1: 8.1 ↖	6: 8.2 ↗	Series	70
2: 7.5 ↙	7: 8.4 ↘		
3: 8.0 ↑	8: 7.0 →	Series	141
4: 5.3 ↗	9: 6.6 ↑		
5: 5.9 ↘	10: 8.9 ↖		

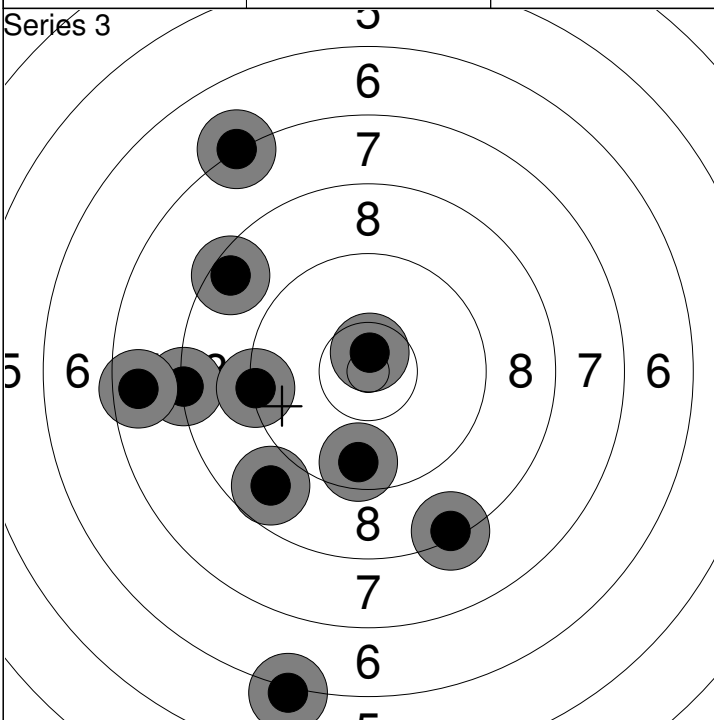

1: 8.3 ←	6: 8.3 ↓	Series	80
2: 8.8 ↙	7: 10.7x ↑		
3: 9.6 ↓	8: 8.5 ↖	Series	221
4: 6.1 ↓	9: 9.3 ←		
5: 7.2 ↗	10: 7.6 ←		

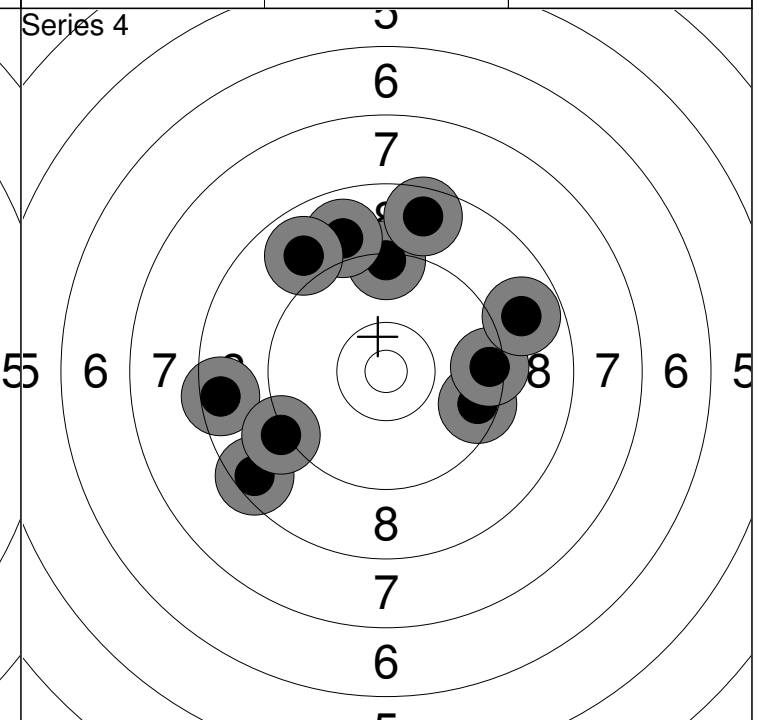

1: 9.3 ↑	6: 8.9 ↖	Series	84
2: 8.5 ←	7: 9.4 →		
3: 8.5 ↙	8: 8.6 ↑	Series	305
4: 9.5 ↘	9: 9.2 ↙		
5: 8.9 ↑	10: 8.8 →		

Mikkelin Ampujat ry

Relay 3	Lane 6	Jorma Åsbacka
-------------------	------------------	----------------------

10m Ilma-ase launtai	MA	Y70p
----------------------	----	------

2.- 3.2.2019	10. Markun ilma-asekilpailu	Mikkeli Shooting Club
--------------	-----------------------------	-----------------------

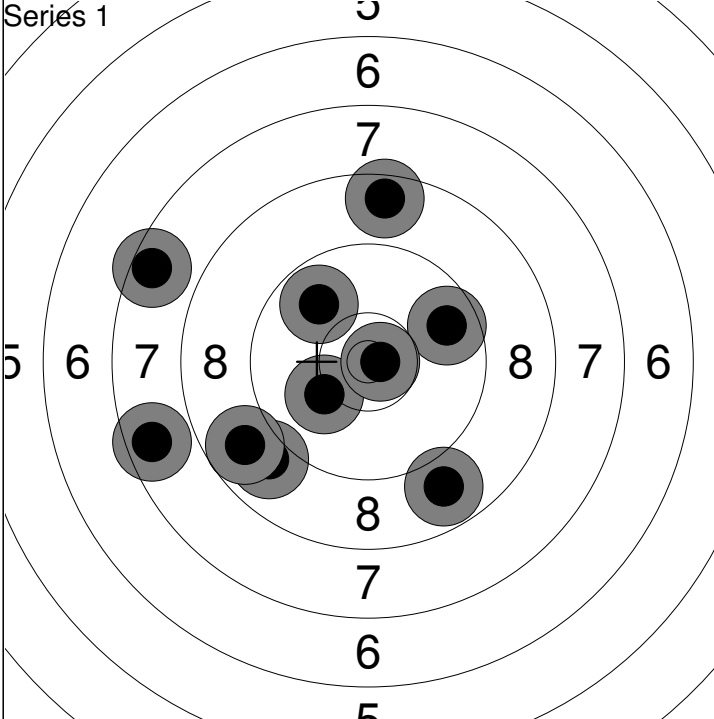

1: 8.8 ↓	6: 9.8 ↗	Series	84
2: 8.9 ↙	7: 7.5 ←		
3: 10.1 ↙	8: 8.8 ↙	Series	84
4: 9.7 ↗	9: 10.8x →		
5: 7.6 ←	10: 8.6 ↑		

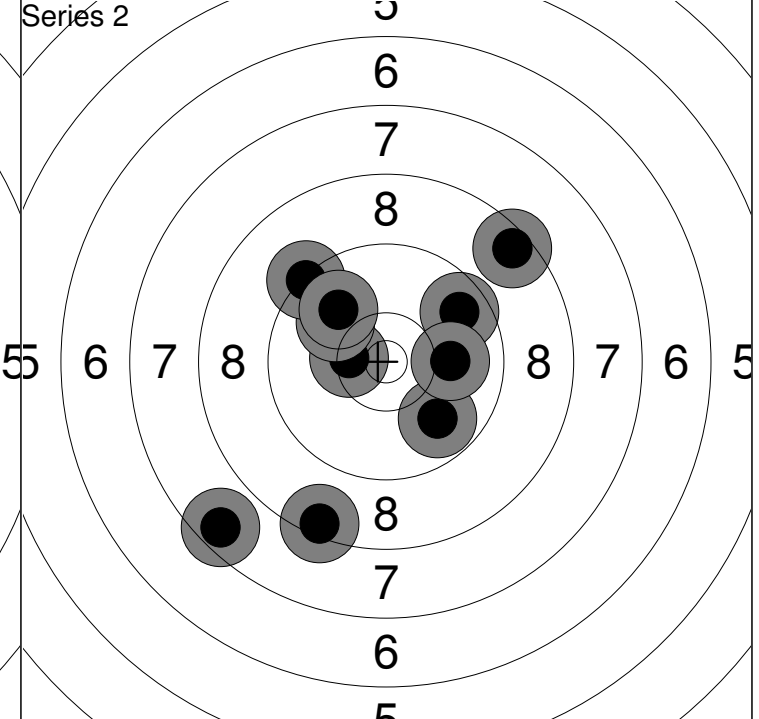

1: 9.8 ↓	6: 7.5 ↙	Series	89
2: 10.4x ←	7: 8.4 ↙		
3: 9.7 ↗	8: 10.0 ↙	Series	173
4: 8.5 ↗	9: 9.3 ↗		
5: 10.0 →	10: 9.9 ↖		

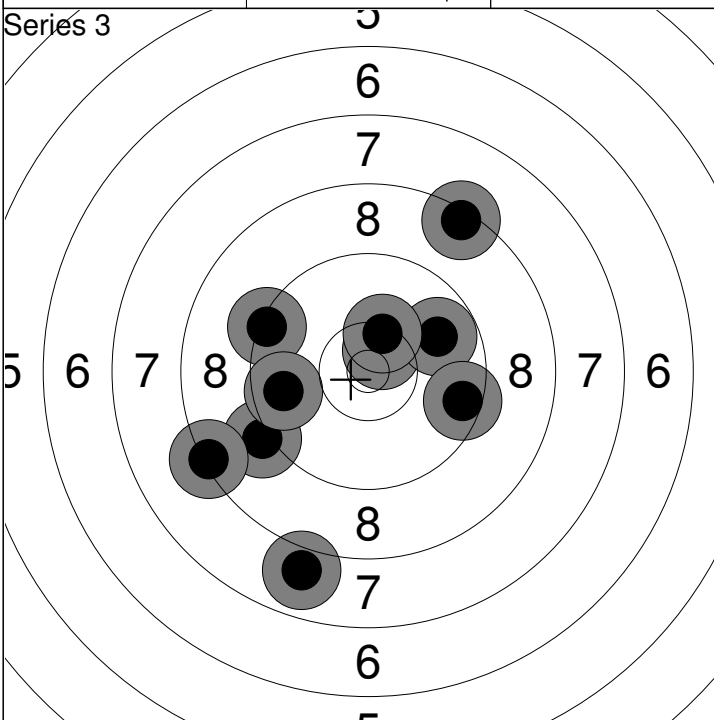

1: 9.1 ↙	6: 7.9 ↓	Series	88
2: 9.3 ↙	7: 8.4 ↗		
3: 10.6x ↗	8: 9.8 ↗	Series	261
4: 8.3 ↙	9: 9.5 →		
5: 9.7 ←	10: 10.4x ↗		

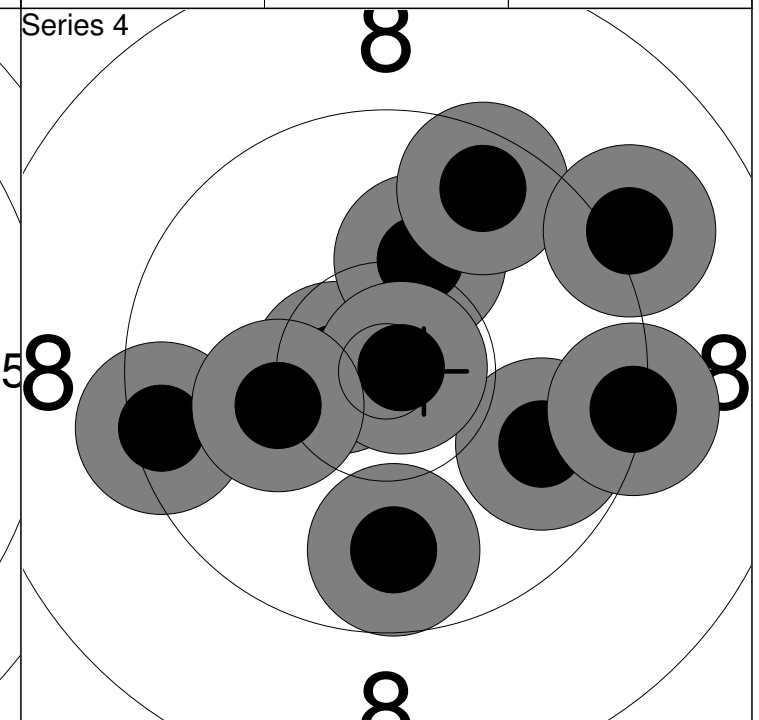

1: 9.4 ←	6: 9.6 ↗	Series	94
2: 10.6x ←	7: 9.3 →		
3: 9.8 ↓	8: 9.1 ↗	Series	355
4: 10.2 ↗	9: 10.8x →		
5: 9.8 →	10: 10.2 ←		

Mikkelin Ampujat ry

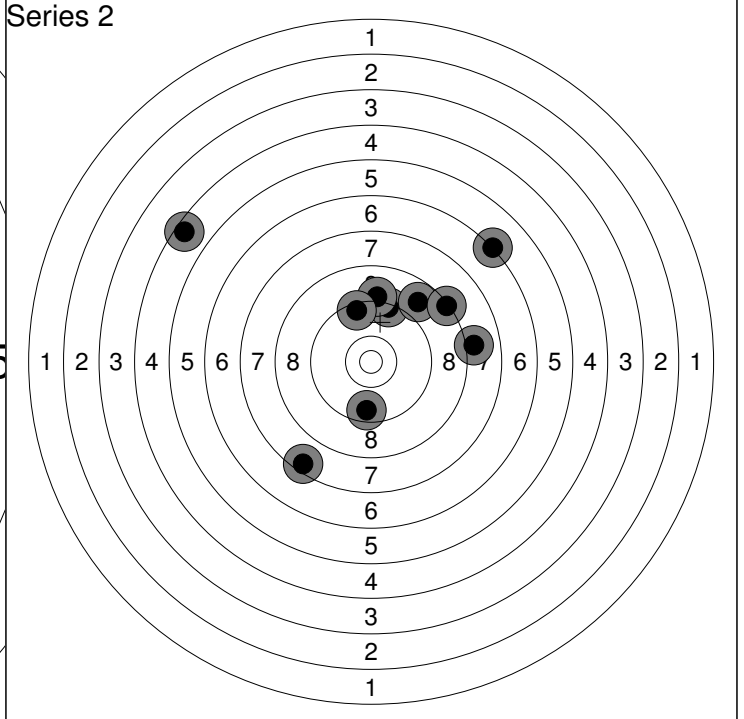
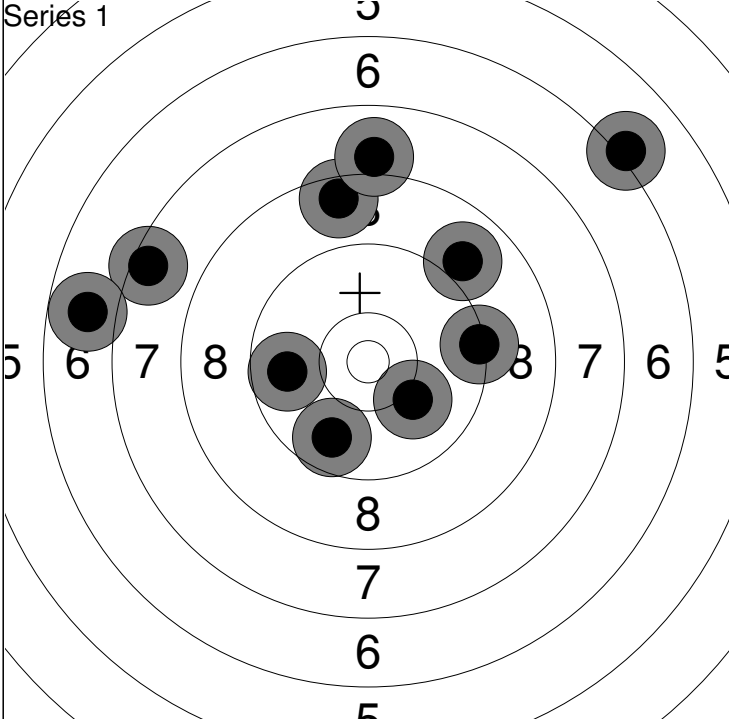

1: 9.3 →	6: 8.9 ↗	Series	80
2: 10.1 ↘	7: 9.8 ←		
3: 6.1 ↗	8: 8.5 ↑	Series	80
4: 7.5 ←	9: 6.8 ←		
5: 9.7 ↓	10: 8.0 ↑		

1: 6.2 ↗	6: 8.0 →	Series	77
2: 9.3 ↑	7: 7.5 ↓		
3: 9.6 ↓	8: 9.1 ↑	Series	157
4: 4.5 ←	9: 8.3 ↗		
5: 8.8 ↗	10: 9.4 ↑		

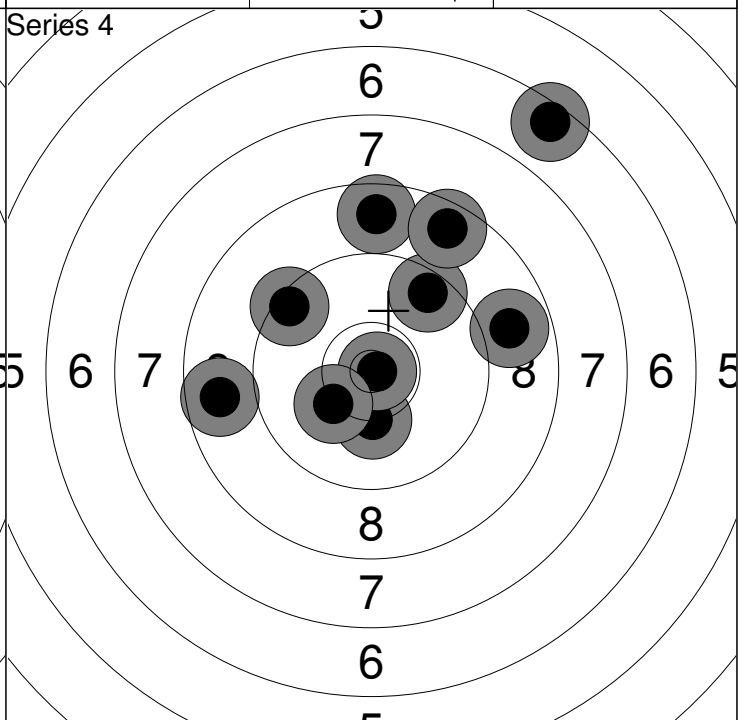
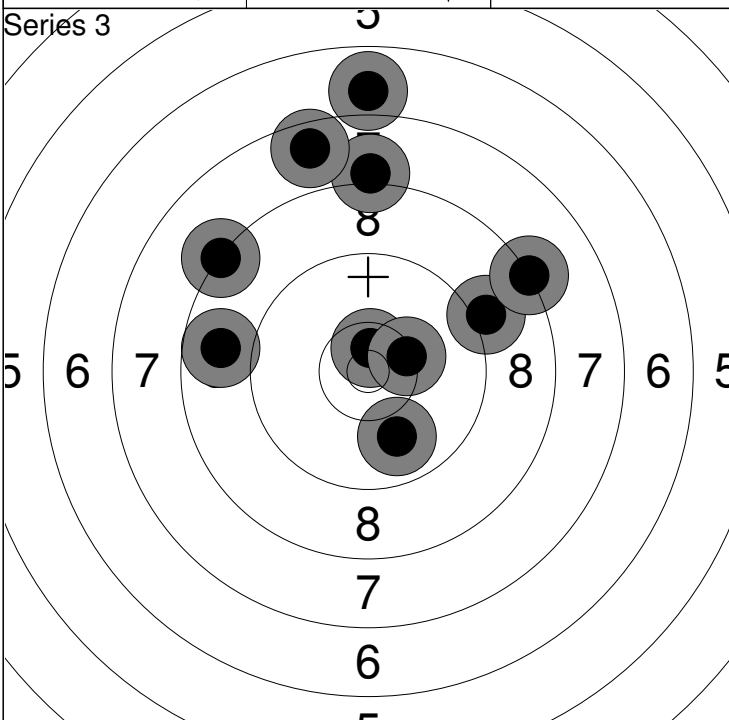

1: 10.6x ↑	6: 9.9 ↓	Series	83
2: 8.8 ←	7: 7.6 ↑		
3: 9.0 ↗	8: 8.2 ↗	Series	240
4: 8.1 ↑	9: 6.9 ↑		
5: 8.2 ←	10: 10.3 →		

1: 10.2 ↓	6: 8.8 →	Series	86
2: 6.5 ↗	7: 9.4 ←		
3: 10.9x →	8: 8.6 ↑	Series	326
4: 8.7 ←	9: 10.2 ↓		
5: 9.5 ↗	10: 8.6 ↑		

Relay 3	Lane 8	Ari Meinander
-------------------	------------------	----------------------

10m Ilma-ase lauantai	SySi	M50p
-----------------------	------	------

2.- 3.2.2019	10. Markun ilma-asekilpailu	Mikkeli Shooting Club
--------------	-----------------------------	-----------------------

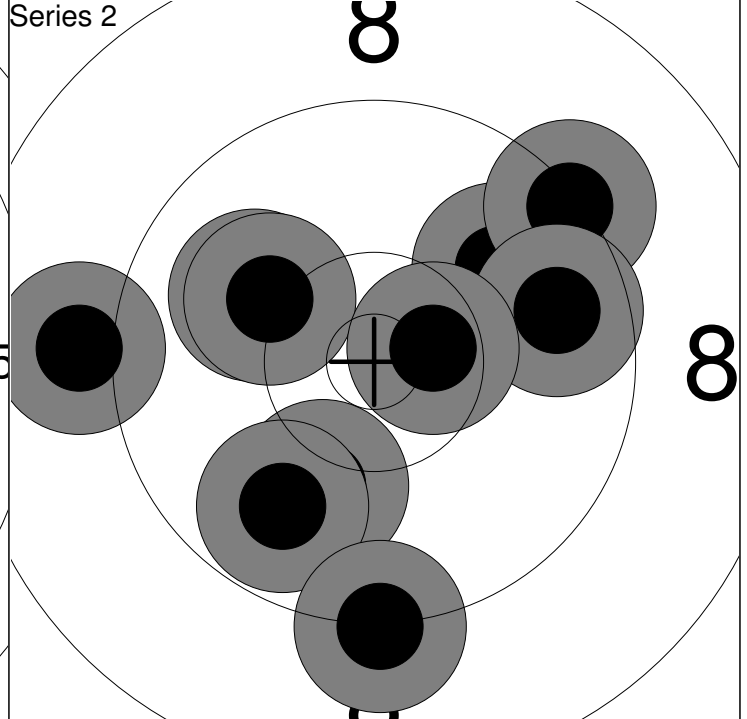
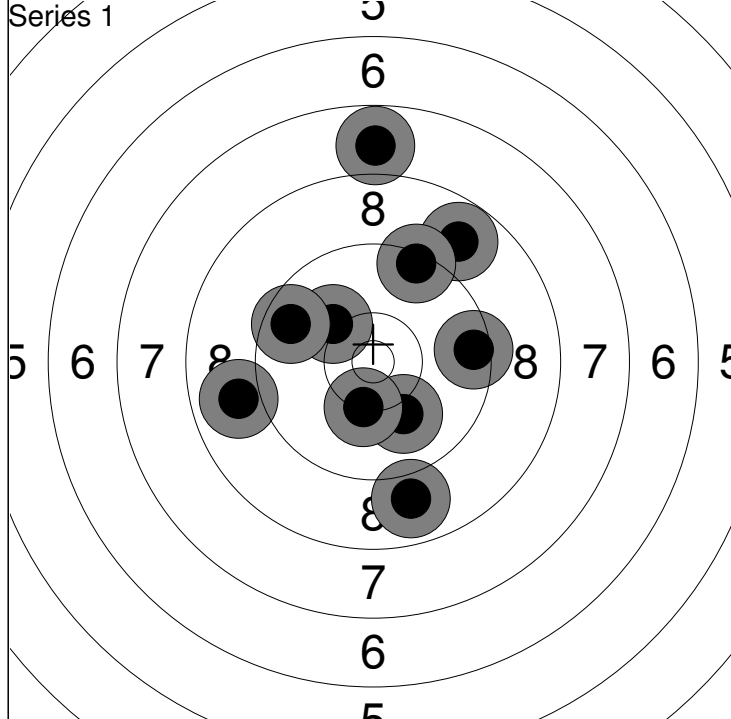

1: 7.8 ↑	6: 8.9 ↓	Series	88
2: 9.5 →	7: 9.6 ←		
3: 10.1 ↓	8: 8.8 ↗	88	
4: 8.9 ←	9: 10.3 ↓		
5: 10.1 ↖	10: 9.4 ↗		

1: 10.0 ↖	6: 9.0 ←	Series	94
2: 10.1 ↓	7: 9.3 ↗		
3: 9.8 ↓	8: 9.7 →	182	
4: 10.1 ↖	9: 10.5x →		
5: 9.9 ↗	10: 9.2 ↓		

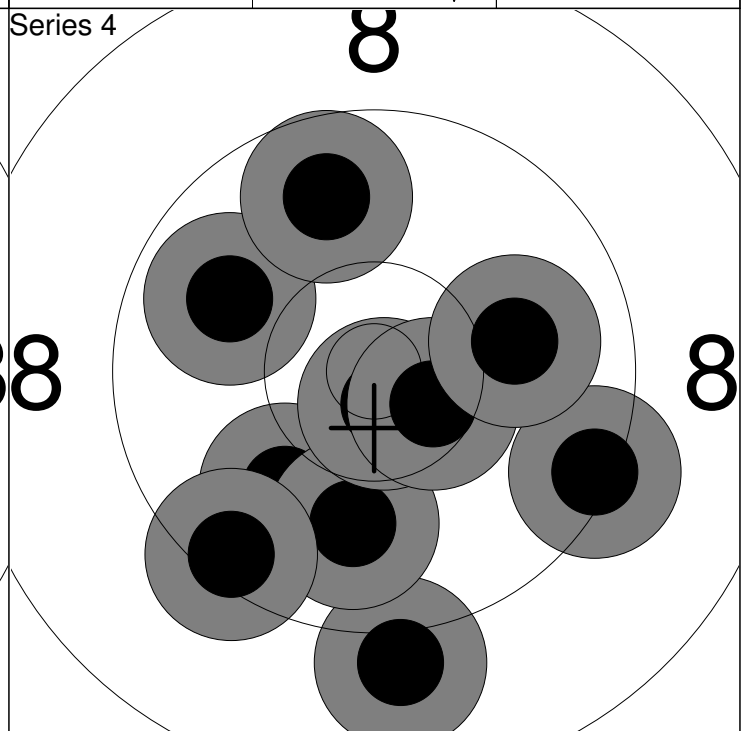
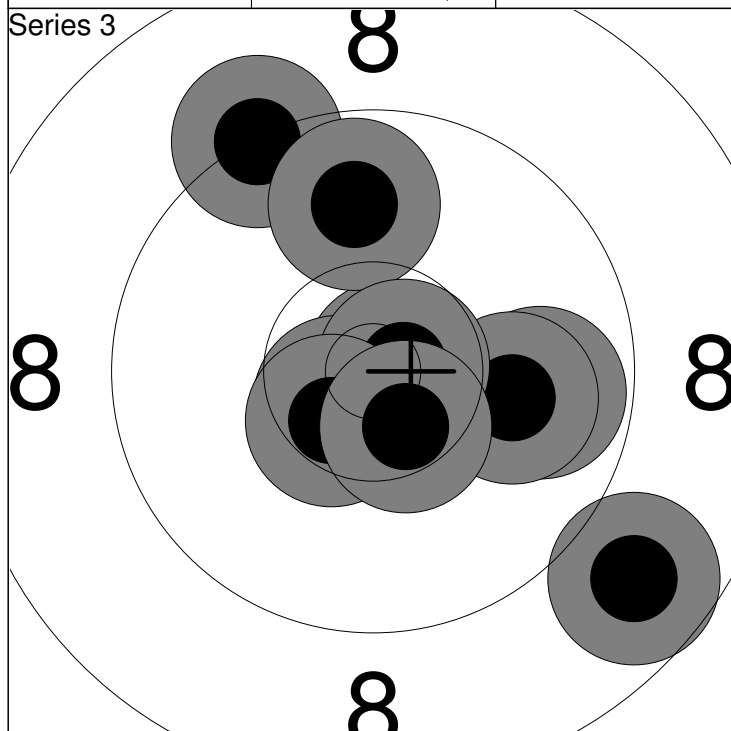

1: 9.8 →	6: 9.8 ↑	Series	95
2: 9.2 ↗	7: 8.7 ↓		
3: 10.0 →	8: 10.7x →	277	
4: 10.8x →	9: 10.5x ↓		
5: 10.6x ↖	10: 10.5x ↓		

1: 10.0 ↓	6: 10.7x ↓	Series	94
2: 9.0 ↓	7: 10.5x ↘		
3: 9.9 ↓	8: 10.0 →	371	
4: 9.9 ↖	9: 9.7 ↑		
5: 9.3 →	10: 9.4 ↓		

Mikkelin Ampujat ry

Relay 3	Lane 10	Antti Pesonen
-------------------	-------------------	----------------------

10m Ilma-ase lauantai	SySi	M60p
-----------------------	------	------

2.- 3.2.2019	10. Markun ilma-asekilpailu	Mikkeli Shooting Club
--------------	-----------------------------	-----------------------

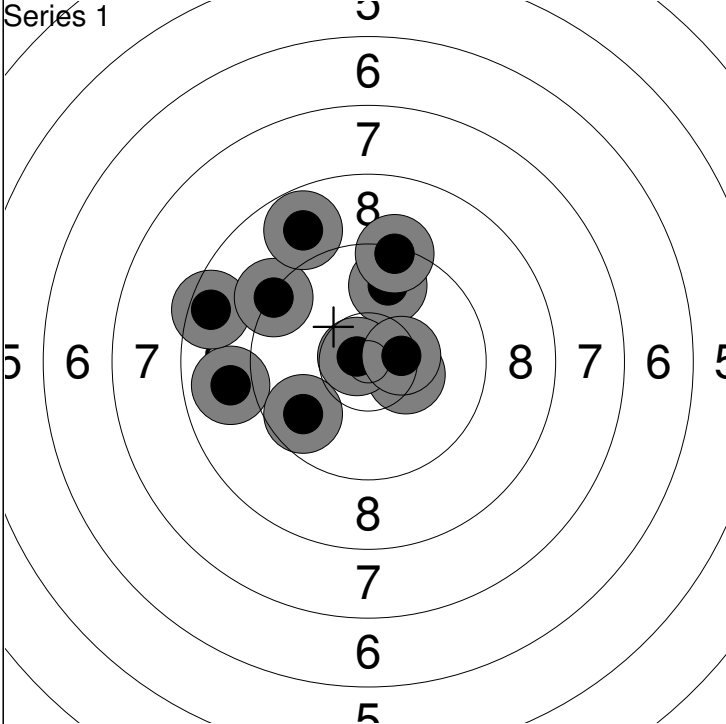

1: 8.9 ←	6: 10.8x ↙
2: 8.5 ↙	7: 9.3 ↗
3: 9.3 ↗	8: 10.5x →
4: 10.4x →	9: 8.8 ↗
5: 9.8 ↗	10: 9.7 ↙

Series	90
	90

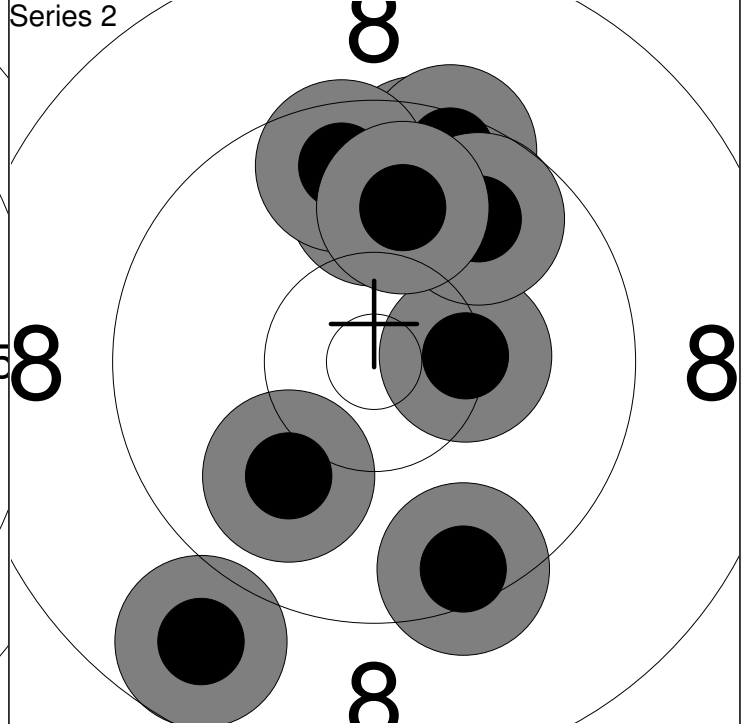

1: 9.5 ↓	6: 10.3 →
2: 9.6 ↗	7: 9.8 ↗
3: 9.9 ↗	8: 8.8 ↙
4: 9.5 ↗	9: 9.9 ↗
5: 9.6 ↗	10: 10.0 ↙

Series	91
	181

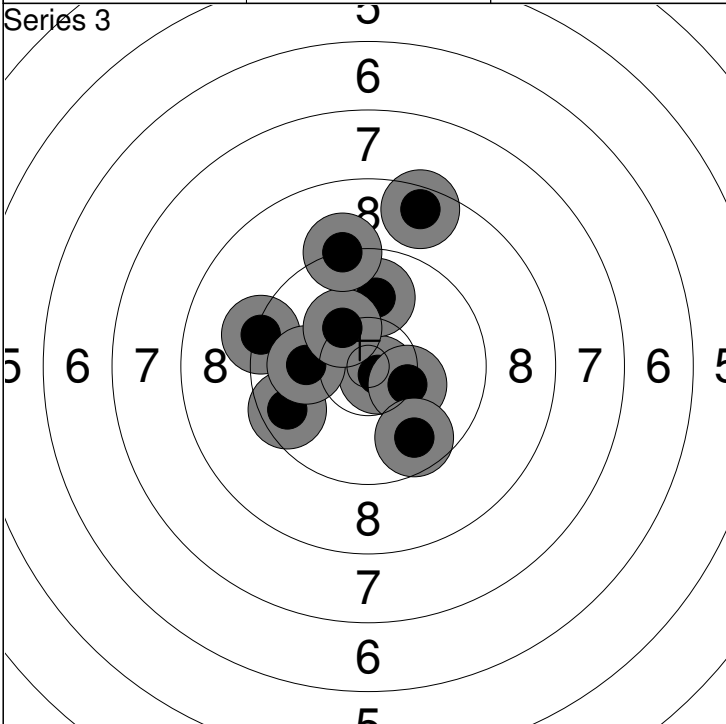

1: 8.5 ↗	6: 10.3 →
2: 10.8x ↙	7: 10.0 ←
3: 9.3 ↙	8: 10.3 ↗
4: 9.9 ↗	9: 9.2 ↗
5: 9.6 ↙	10: 9.7 ↙

Series	93
	274

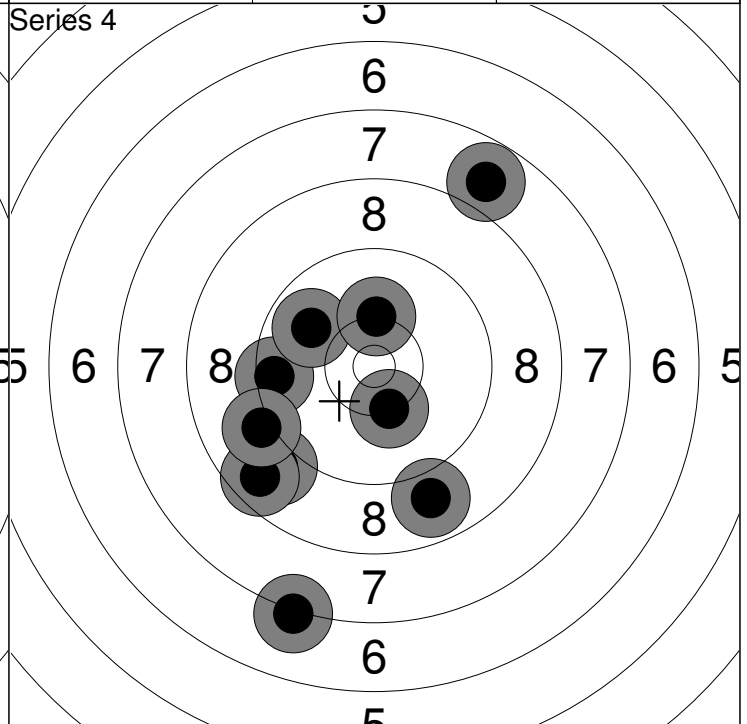

1: 8.9 ↙	6: 7.2 ↓
2: 7.8 ↗	7: 8.9 ↓
3: 9.5 ←	8: 9.1 ↙
4: 8.6 ↙	9: 9.9 ↙
5: 10.3 ↓	10: 10.2 ↗

Series	85
	359

Mikkelin Ampujat ry

Relay 4	Lane 1	Arttu Lång	
10m Ilma-ase lauantai		MyA	M20
2.- 3.2.2019		10. Markun ilma-asekilpailu	Mikkeli Shooting Club
Series 1		1: 10.5x ← 2: 10.7x → 3: 9.1 ↗ 4: 10.1 ↓ 5: 10.7x ↑ 6: 10.4x → 7: 10.1 ← 8: 9.5 ← 9: 10.4x ↗ 10: 9.9 ↙	Series 2
		Series 101.4	Series 101.2
		101.4	202.6
Series 3		1: 10.1 ↗ 2: 10.5x ← 3: 10.4x ↘ 4: 10.1 ↗ 5: 9.5 ↘ 6: 9.4 ↘ 7: 9.8 ↑ 8: 10.2x ← 9: 8.8 ↓ 10: 10.0 ↙	Series 4
		Series 98.8	Series 97.5
		301.4	398.9
Series 5		1: 9.2 ↓ 2: 10.0 ↓ 3: 8.8 ↗ 4: 10.4x ← 5: 10.5x ↗ 6: 9.9 ↗ 7: 10.3x ← 8: 10.0 ↙ 9: 9.1 ← 10: 10.4x ↗	Series 6
		Series 98.6	Series 102.8
		497.5	600.3

Relay	Lane	Mika Varjo	
4	3	10m Ilma-ase launtai	MA
2.- 3.2.2019		10. Markun ilma-asekilpailu	M20
Series 1		Series 2	Mikkeli Shooting Club
	1: 10.7x → 2: 10.8x ↑ 3: 10.1 ← 4: 9.1 ← 5: 10.0 ↑ 6: 9.9 ↓ 7: 10.5x ↗ 8: 8.4 ← 9: 10.3x ↖ 10: 10.5x ↗		1: 10.0 → 2: 10.2x ↑ 3: 10.5x ↗ 4: 10.2x → 5: 10.2x → 6: 10.5x ↓ 7: 8.6 → 8: 10.5x ↓ 9: 10.5x ↗ 10: 9.8 ←
	Series 100.3		Series 101.0
	100.3		201.3
Series 3	Series 4	Series 5	Series 6
	1: 9.8 ← 2: 10.5x ↗ 3: 10.2x ↖ 4: 9.9 ← 5: 9.3 → 6: 10.1 ↓ 7: 10.3x → 8: 10.2x ↖ 9: 10.2x ↓ 10: 10.2x ↗		1: 10.9x → 2: 10.2x ↓ 3: 9.8 → 4: 9.0 → 5: 10.0 → 6: 10.4x ↓ 7: 9.5 → 8: 9.6 ← 9: 10.5x ↖ 10: 10.1 ←
	Series 100.7		Series 100.0
	302.0		402.0
	1: 10.5x ↖ 2: 10.4x → 3: 9.9 ↗ 4: 9.8 ↗ 5: 10.4x ↗ 6: 9.9 ← 7: 10.6x ↑ 8: 9.5 ← 9: 10.6x ↑ 10: 9.4 ←		1: 10.6x ↗ 2: 10.0 ← 3: 10.5x → 4: 9.9 → 5: 10.0 ↗ 6: 9.7 → 7: 10.5x ↗ 8: 10.2x ↑ 9: 10.6x ↗ 10: 9.9 ←
	Series 101.0		Series 101.9
	503.0		604.9

Relay 4	Lane 4	Iida Tolvanen			
10m Ilma-ase lauantai		JA	N20		
2.- 3.2.2019		10. Markun ilma-asekilpailu	Mikkeli Shooting Club		
Series 1		1: 8.6 ↗ 2: 9.4 ↑ 3: 9.0 ↘ 4: 9.7 ↗ 5: 10.2x← 6: 10.1 ↗ 7: 10.7x→ 8: 8.7 ↖ 9: 8.6 ↗ 10: 10.3x↓ Series 95.3 95.3	Series 2		1: 10.5x↗ 2: 9.3 ↖ 3: 10.4x← 4: 8.2 ↗ 5: 10.1 ↑ 6: 9.3 ↖ 7: 9.1 ↖ 8: 9.8 ↗ 9: 10.7x↑ 10: 10.5x→ Series 97.9 193.2
Series 3		1: 9.9 ↓ 2: 9.1 ↗ 3: 9.3 ↗ 4: 10.0 ↑ 5: 10.8x↑ 6: 9.4 ↗ 7: 9.9 ↖ 8: 9.5 ↖ 9: 9.8 ↗ 10: 8.8 ↖ Series 96.5 289.7	Series 4		1: 9.7 ↖ 2: 10.7x→ 3: 9.5 ↗ 4: 9.5 → 5: 9.8 ↖ 6: 8.9 ↖ 7: 9.9 ↑ 8: 10.4x↖ 9: 10.5x↓ 10: 10.1 ↖ Series 99.0 388.7
Series 5		1: 9.5 ↖ 2: 10.3x↗ 3: 10.1 ↗ 4: 9.5 → 5: 8.8 ↗ 6: 10.0 ↖ 7: 9.2 ↗ 8: 9.7 ↖ 9: 9.9 ↓ 10: 10.2x↖ Series 97.2 485.9	Series 6		1: 9.9 → 2: 9.8 ↖ 3: 10.4x→ 4: 9.9 ↖ 5: 10.8x↗ 6: 10.2x↑ 7: 9.9 ↓ 8: 9.9 ↓ 9: 9.1 ↖ 10: 10.2x↑ Series 100.1 586.0

Relay	Lane	Elina Bisi	
4	5	10m Ilma-ase launtai	MA
2.- 3.2.2019		10. Markun ilma-asekilpailu	Mikkeli Shooting Club
Series 1		1: 10.5x →	Series 2
		2: 10.0 →	
3: 9.9 ↑		3: 9.9 ↑	1: 10.6x ↑
4: 8.6 ↓		4: 8.6 ↓	2: 10.4x ↑
5: 10.4x ↗		5: 10.4x ↗	3: 9.8 ↖
6: 9.7 ←		6: 9.7 ←	4: 10.6x ↑
7: 9.8 ↖		7: 9.8 ↖	5: 10.4x ↗
8: 10.7x →		8: 10.7x →	6: 8.9 ↗
9: 9.9 ↘		9: 9.9 ↘	7: 10.4x →
10: 10.0 ←		10: 10.0 ←	8: 9.7 ↙
Series 99.5		Series 101.5	9: 10.6x →
99.5		201.0	10: 10.1 ←
Series 3		Series 4	Series 5
1: 10.8x ↗		1: 10.1 →	1: 9.5 ↗
2: 9.7 ←		2: 10.5x →	2: 10.0 ↓
3: 9.5 ↖		3: 9.6 ↑	3: 9.4 ↖
4: 10.0 ↑		4: 10.2x ↑	4: 9.1 ↓
5: 9.9 ←		5: 9.6 →	5: 9.8 ↖
6: 10.6x ↗		6: 8.7 ←	6: 8.9 ↙
7: 9.8 ↘		7: 10.1 ↑	7: 10.5x ←
8: 9.5 ↙		8: 10.6x →	8: 9.8 ←
9: 10.5x ↗		9: 9.9 ↘	9: 10.2x →
10: 10.7x →		10: 10.1 ↖	10: 9.0 ↖
Series 101.0		Series 99.4	Series 96.2
302.0		401.4	497.6
Series 5		Series 6	Series 7
1: 9.5 ↗		1: 9.7 ←	1: 9.7 ←
2: 10.0 ↓		2: 9.6 ↖	2: 9.6 ↖
3: 9.4 ↖		3: 10.3x ↘	3: 10.3x ↘
4: 9.1 ↓		4: 10.5x ↗	4: 10.5x ↗
5: 9.8 ↖		5: 10.2x ↖	5: 10.2x ↖
6: 8.9 ↙		6: 10.2x ↑	6: 10.2x ↑
7: 10.5x ←		7: 10.4x ↖	7: 10.4x ↖
8: 9.8 ←		8: 10.7x ↗	8: 10.7x ↗
9: 10.2x →		9: 8.7 ←	9: 8.7 ←
10: 9.0 ↖		10: 10.8x ↑	10: 10.8x ↑
Series 96.2		Series 101.1	Series 101.1
497.6		598.7	598.7

<p>Series 1</p>	<p>1: 7.3 ↗ 2: 10.2 ➤ 3: 9.8 ↘ 4: 9.5 ➔ 5: 8.5 ↗ 6: 9.8 ↘ 7: 10.0 ↘ 8: 10.3 ↑ 9: 8.1 ↑ 10: 8.7 ➤</p> <p>Series 92.2 92.2</p>	<p>Series 2</p>	<p>1: 8.3 ↑ 2: 9.2 ← 3: 9.3 ↑ 4: 9.1 ↗ 5: 8.0 ↑ 6: 9.8 ↖ 7: 6.4 ↘ 8: 10.2 ➔ 9: 9.9 ↘ 10: 8.3 ←</p> <p>Series 88.5 180.7</p>
-----------------	--	-----------------	---

<p>Series 3</p>	<p>1: 8.3 ↘ 2: 9.0 ↘ 3: 9.8 ← 4: 9.0 ↘ 5: 9.4 ↘ 6: 9.0 ← 7: 10.6x ↘ 8: 9.3 ← 9: 9.5 ↗ 10: 7.0 ←</p> <p>Series 90.9 271.6</p>	<p>Series 4</p>	<p>1: 9.2 ← 2: 10.0 ➔ 3: 9.5 ← 4: 10.7x ↑ 5: 9.5 ← 6: 8.6 ↗ 7: 10.4 ↗ 8: 9.7 ↖ 9: 8.1 ↘ 10: 8.7 ↑</p> <p>Series 94.4 366.0</p>
-----------------	--	-----------------	--

<p>Series 5</p>	<p>1: 9.7 ↘ 2: 10.1 ← 3: 8.5 ↘ 4: 9.5 ↘ 5: 8.5 ↑ 6: 9.0 ← 7: 9.5 ↗ 8: 8.0 ← 9: 10.1 ➔ 10: 9.2 ↘</p> <p>Series 92.1 458.1</p>	<p>Series 6</p>	<p>1: 10.0 ➔ 2: 9.3 ↗ 3: 9.6 ↗ 4: 8.7 ↗ 5: 10.7x ↘ 6: 8.7 ↗ 7: 6.7 ↖ 8: 9.4 ← 9: 9.3 ↘ 10: 9.8 ↖</p> <p>Series 92.2 550.3</p>
-----------------	--	-----------------	---

<p>Series 1</p>	<p>1: 7.8 → 2: 10.2 ↓ 3: 9.4 ↗ 4: 7.5 ↓ 5: 9.4 ↓ 6: 10.4 → 7: 8.2 ↗ 8: 9.5 ↑ 9: 9.6 ↓ 10: 8.8 ←</p> <p>Series 90.8 90.8</p>	<p>Series 2</p>	<p>1: 9.4 ↓ 2: 6.1 ↗ 3: 9.6 ↓ 4: 9.8 ← 5: 7.8 ↑ 6: 7.9 → 7: 6.6 ↗ 8: 9.6 ↓ 9: 9.0 ↑ 10: 9.6 ↗</p> <p>Series 85.4 176.2</p>
-----------------	---	-----------------	--

<p>Series 3</p>	<p>1: 6.3 ↓ 2: 9.0 ↑ 3: 9.4 → 4: 10.3 ↓ 5: 7.7 ↓ 6: 8.6 ↓ 7: 9.0 ↗ 8: 8.1 ↓ 9: 9.1 ← 10: 9.8 ↑</p> <p>Series 87.3 263.5</p>	<p>Series 4</p>	<p>1: 7.9 ← 2: 9.9 ← 3: 8.8 ↓ 4: 9.7 ↗ 5: 9.7 → 6: 9.4 ↗ 7: 10.3 ↓ 8: 9.8 ↓ 9: 9.0 ↑ 10: 8.4 ↗</p> <p>Series 92.9 356.4</p>
-----------------	---	-----------------	---

<p>Series 5</p>	<p>1: 10.0 ↗ 2: 10.0 → 3: 9.9 ↗ 4: 9.7 ↓ 5: 9.8 ↗ 6: 9.1 ← 7: 7.5 ↑ 8: 10.2 ↓ 9: 10.1 ↗ 10: 9.4 ←</p> <p>Series 95.7 452.1</p>	<p>Series 6</p>	<p>1: 9.8 ↑ 2: 8.0 → 3: 8.5 ↗ 4: 8.4 ↓ 5: 8.6 ↓ 6: 10.5x ↘ 7: 7.6 ↑ 8: 10.6x ↓ 9: 8.9 ↗ 10: 10.4x ↘</p> <p>Series 91.3 543.4</p>
-----------------	--	-----------------	--

Relay	Lane	Kati Tornainen	
4	8	10m Ilma-ase lauantai	MA
2.- 3.2.2019		10. Markun ilma-asekilpailu	Mikkeli Shooting Club
Series 1		1: 9.1 ↘ 2: 8.3 ↙ 3: 9.3 ↗ 4: 9.9 ↗ 5: 6.5 ↗ 6: 10.1 ↙ 7: 9.3 ↗ 8: 9.4 ↗ 9: 8.7 ↙ 10: 7.9 ↗ Series 88.5 88.5	Series 2 1: 9.2 ↗ 2: 10.0 ↖ 3: 8.9 ↗ 4: 8.1 ↘ 5: 8.9 → 6: 9.2 ← 7: 8.1 → 8: 10.2 ↘ 9: 8.4 ↗ 10: 9.6 → Series 90.6 179.1
Series 3		1: 9.1 ↘ 2: 9.0 → 3: 8.7 ↘ 4: 9.7 ↗ 5: 9.5 ↘ 6: 8.7 ← 7: 10.4x ↙ 8: 10.3 ← 9: 8.7 ← 10: 10.2 → Series 94.3 273.4	Series 4 1: 9.5 ↘ 2: 10.5x ↘ 3: 9.9 ↗ 4: 8.0 → 5: 8.7 ↖ 6: 7.1 ↗ 7: 8.5 ↘ 8: 9.4 ↗ 9: 8.5 ↗ 10: 6.5 ↗ Series 86.6 360.0
Series 5		1: 8.6 ← 2: 8.2 ↗ 3: 8.8 ↙ 4: 8.4 ↘ 5: 10.3 ↘ 6: 10.1 ↘ 7: 9.1 ↘ 8: 7.4 → 9: 10.4x ↗ 10: 9.2 ↘ Series 90.5 450.5	Series 6 1: 8.9 ← 2: 8.3 ↗ 3: 7.0 ← 4: 10.5x ↖ 5: 9.4 ← 6: 6.3 ← 7: 10.1 ↘ 8: 9.6 ↖ 9: 9.1 ↘ 10: 10.1 ↘ Series 89.3 539.8